



GROUPE  
**THERMO**  
technologies

**EDM WIRES**

# EXCELLENCE IN WIRES

## 02 | WHO WE ARE

A world market leading specialist in EDM: we support our client with excellence for over 45 years

## 06 | CHOOSE YOUR WIRE

About precision and threading

## 08 | MAKE AN EASY CHOICE VISUALLY

3 criteria & usage recommended



## 10-50 | WIRES ACCORDING TO YOUR PRODUCTION NEEDS:

### 10 | VERY HIGH SPEED & PRECISION

THERMO XCC®  
THERMO TEX®  
THERMO SWX®

### 18 | HIGH SPEED & PRECISION

THERMO SE®  
THERMO SWD®  
THERMO SWW®  
THERMO D®

### 28 | SPEED & PRECISION

THERMO SO®  
THERMO SO2®  
THERMO JP®  
THERMO JP2®  
THERMO JP+®

### 40 | SUPER PRECISION & SPEED

THERMO SA+®  
THERMO SA®  
THERMO SWA®  
THERMO SWS®  
THERMO A®

### 54 | ALL PURPOSE

THERMO BRASS 1000®  
THERMO BRASS 900®  
THERMO BRASS 500®  
THERMO BRASS 400®  
THERMO FIRST 900/500®

### 62 | ZINC FREE

THERMO ZF®  
THERMO ZF+®  
THERMO ZF sigma®

## 70 | PLAN YOUR PRODUCTION

## 72 | PLAN YOUR ORDERS – STORAGE CONDITIONS





Innovative coatings and wires for high tech industry

Locations on 3 continents : Europe, Asia and America.

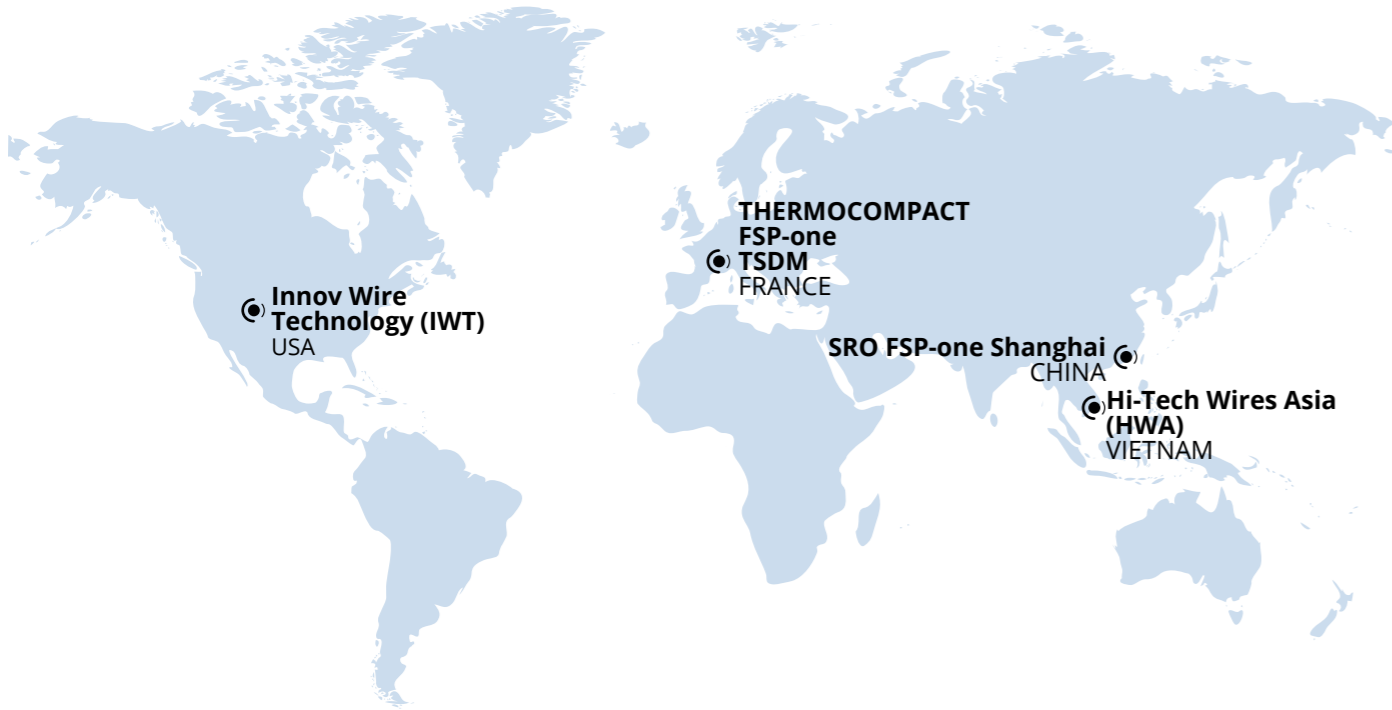

We seek excellence to be world leader in our niche markets and offer the best:

- INNOVATION
- PERFORMANCE
- COMPETITIVENESS

to meet the expectations of our industrial customers with applications in high technology sectors : **aeronautics, space, telecom, automotive, connector technology, general and fine mechanics, health, optical, photovoltaics...**

### PROFICIENT IN 6 ORIGINAL CORE BUSINESSES

WE MANUFACTURE:

- › High-end wires for **EDM**,
- › High value added **technical surface coating**: electrolytic, thermal and chemical processes,
- › **Speciality coated wires** for specific electrical cables,
- › **Metal heat chemical** treatments,
- › **Diamond electroplated wires** for photovoltaic, electronic and sapphire applications,
- › **Diamond wire saws** for slicing hard and brittle materials.

### ECO FRIENDLY SOLUTIONS TO PROTECT OUR PLANET RESOURCES

- › We prefer short circuits for the supplies of raw materials.
- › We are committed to zero pollution. All our technological processes continuously improve the waste recycling and eliminate any chemical pollution.
- › Our innovative solutions allow energy savings on manufacturing equipment.

### INNOVATION: PART OF OUR DNA

Forward-looking, with a dynamic and proven approach of continuous progress and innovation, our **Research and Development** team pushes the limit of performance of the process and products and works continuously on new material structures: R&D's group regularly demonstrates results including **world wide patents** that cover innovative EDM wires and manufacturing processes.

**As an international leader and to answer to the needs of our industrial partner and clients in the course of excellence and innovation**, we develop every year innovative products and processes in terms of performance, productivity and quality constancy.

More than 18 patents for product and process  
2% revenues invested every year in R&D  
Major partnerships with research centers, innovation clusters and global corporations

## SMART SPOOL®

By THERMO COMPACT

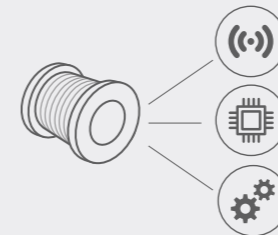

**CAPTURE  
RECORD  
DELIVER  
INFORMATION**

### WORLDWIDE TRACEABILITY

Its ingenious on-board electronic system with tracking sensors gives all informations to support:

- stock management
- traceability
- weight & length
- humidity control
- temperature
- shocks

- › Traceability
- › Technical data control
- › Production management

An innovation protected by the patent EP 3 356 076



## EDM WIRES: KNOW HOW AND EXPERTISE FOR MANY YEARS



Hi-Tech WIRES ASIA, since 2007, manufactures in Vietnam the best performing and innovative EDM wires, based on the know-how and the expertise of Thermo-technologies group in electroplating. HWA deserves the Asian and the American markets with the best quality and reliability existing for EDM wires.



THERMOCOMPACT, with more than 100 years of experience and know-how acquired in electroplating, designs and manufactures in France the best performing and innovative EDM wires for its clients in high technology sectors.

Today THERMOCOMPACT engineers and works on world class production lines and is considered the world-wide leader in EDM wires, specialised in electroplating.



Both, THERMOCOMPACT and HWA, support their industrial customers to reach their goals of technical and improved productivity, applying the thermo-technology group founding values:

**EXPERTISE  
EXCELLENCE  
INNOVATION**

### THERMOCOMPACT: THE ORIGINAL PATENT HOLDER FOR "GAMMA", "GAMMA WITHOUT DISTRIBUTION", AND "BETA/GAMMA" EDM WIRES

We have developed :



The first coated EDM wire in 1973: **THERMO X**®

The fastest EDM wires in 2002: **THERMO XCC**®

The market reference for precision in 2007: **THERMO SA**®

A new EDM wire with combination between speed and accuracy: **THERMO SD2**® and **JP2**® in 2012

The next generation of EDM wire in 2019: **THERMO SA+**® and **THERMO JP+**®



### WE SUPPORT OUR CUSTOMERS IN ACHIEVING EXCELLENCE SINCE A LONG TIME WITH HIGH VALUE EDM WIRES RESULTING IN MAJOR PRODUCTIVITY GAINS

We partner with our clients, the mechanical and micro-mechanical manufacturers to offer high added value wires adapted for precision and productive machining.

- › Our **wide range of EDM wires** offers more than 25 EDM wires, from brass to last generation of patented coated wires.
- › Our high-tech wires **can machine any type of metal part** regardless of hardness, complexity and precision.

We continuously adapt our EDM wires to the combined needs of performance of our customers for many applications: cutting tools, molds and dies, highly sophisticated parts manufactured for medical equipment, aerospace, watchmaking, connectors, precision mechanical parts etc...

### WE OFFER PERSONALISED SERVICE AND LONG TERM TECHNICAL PARTNERSHIP INCLUDING:

- › **Personalised recommendations** on machine issues, wherever our customers are in the world
- › **A long-term support**, establishing a **knowledge-sharing plan** with our customers to ensure continuous improvement for EDM wire performances, and greater return on investment.

# CHOOSE YOUR WIRE

## ABOUT PRECISION

Our coated wire combined with a dedicated technology setup on machine will provide you the best precision:

The precision of the part is the result of:



- THE MACHINE
- THE PART
- THE TECHNOLOGY
- THE WIRE
- THE TEMPERATURE

### MACHINES SOLUTIONS

YOUR NEED	WIRE	+GF+			OWA	Sodick	FANUC	MITSUBISHI	MAKINO	VOLLMER	Seibu
		MICRO MACHINING & TOP END ACCURACY	HIGH SPEED MACHINING	GENERAL PURPOSE							
VERY HIGH SPEED & PRECISION	THERMO XCC®		■	■							
	THERMO TEX®		■	■	■						
	THERMO SWX®		■	■	■						
HIGH SPEED & PRECISION	THERMO SE® *	■	■	■	■	■	■	■	■	■	■
	THERMO SWD®	Offered for certified processes which are still in operation									
	THERMO SWW®										
	THERMO D®										
SPEED & PRECISION	THERMO SD®	■	■	■						■	
	THERMO SD2®	■	■	■							
	THERMO JP® **				■	■	■	■	■	■	■
	THERMO JP2® **				■	■	■	■	■	■	■
	THERMO JP+® **				■	■	■	■	■	■	■
SUPER PRECISION & SPEED	THERMO SA+®	■	■								
	THERMO SA®	■	■								
	THERMO SA 500®		■								
	THERMO SA 400®		■								
	THERMO SWA®	■	■		■	■	■	■	■	■	■
	THERMO SWS®		■								
	THERMO A®	■	■								
ALL PURPOSE	THERMO BRASS 1000®				■	■	■	■			
ZINC FREE	THERMO ZF®		■		■						
	THERMO ZF+®	■	■	■	■	■	■	■	■	■	■
	THERMO ZFsigma®	■	■	■	■	■	■	■	■	■	■

## ABOUT THREADING

Most modern EDM machines use a thermal system to prepare the wire before automatic threading. They make the wire straight themselves. This operation on the machine allows the wire to be straight enough for

threading. Thus, they can automatically thread curved wires such as soft brass (500N/mm<sup>2</sup> and 400N/mm<sup>2</sup>). Some machines still require the wire to be straight, or to be flexible enough to remain in the threading jet.

YOUR NEED	WIRE	LEVEL OF STRAIGHTNESS	PAGE
VERY HIGH SPEED & PRECISION	THERMO XCC®	C	14
	THERMO TEX®	C	16
	THERMO SWX®	C	18
HIGH SPEED & PRECISION	THERMO SE® *	B	22
	THERMO SWD®	B	24
	THERMO SWW®	C	26
	THERMO D®	B	28
SPEED & PRECISION	THERMO SD®	A	30
	THERMO SD2®	B	32
	THERMO JP® **	A	34
	THERMO JP2® **	B	36
	THERMO JP+® **	A	38
SUPER PRECISION & SPEED	THERMO SA+®	A	42
	THERMO SA®	A	44
	THERMO SA 500®	B	46
	THERMO SA 400®	C	46
	THERMO SWA®	A	48
	THERMO SWS®	B	50
	THERMO A®	A	52
ALL PURPOSE	THERMO BRASS 1000®	A	56
ZINC FREE	THERMO ZF®	C	64
	THERMO ZF+®	B	66
	THERMO ZFsigma®	B	68

- A** the wire is straight
- B** the wire is less straight, but it is flexible enough to thread automatically on most systems, provided the water jet is strong enough
- C** the wire should be thermally straightened by the machine or be threaded by hand

\* THERMO SE® is an high speed wire. To obtain its best performance, some parameters can be pushed.

\*\* We have designed THERMO JP®, THERMO JP2® and THERMO JP2+® to fit with Japanese machines with its original brass parameters.

# MAKE AN EASY CHOICE VISUALLY

 In the following pages, the radar graph shows the performances of our wires compared to the standard brass.

## CHOOSE YOUR WIRE WITH 3 CRITERIA

**O.E.E.**  
**Overall Equipment Effectiveness**

Refers to the process performance improvement, compared to the time needed for the wire-related maintenance of the machine. If, for example, the set up time is reduced, the O.E.E. will increase more product for less resource. The maintenance related to the wire includes:

- Replacement current feeders
- Wire guides cleaning, and re-alignment of heads

**TOP PERFORMANCE**

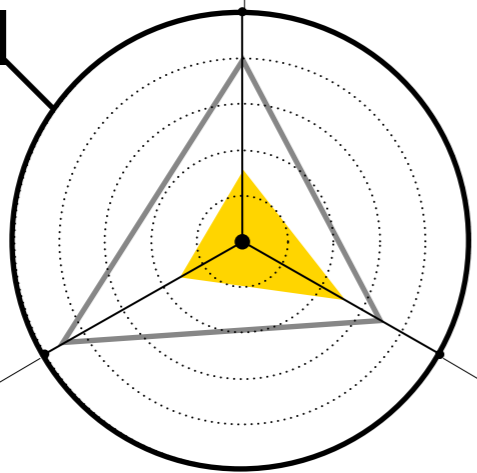

### SPEED

Refers to the average speed of a wire. The radars compare coated wires to brass, in the same flushing conditions.

Coating enhances not only the rough cut's speed but also the cutting speed of some trims.

### QUALITY

Refers to the best surface finish a wire can achieve, and to the best positioning accuracy during electrical edge sensing.

## USAGE RECOMMENDED



**AERONAUTICS**

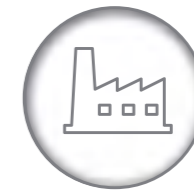

**GENERAL MECHANIC**



**FINE MECHANIC**



**MEDICAL**



**MOLDS**



**DIES AND TOOLS**



# VERY HIGH SPEED & PRECISION

## WIRES DEDICATED

THERMO XCC®

THERMO TEX®

THERMO SWX®

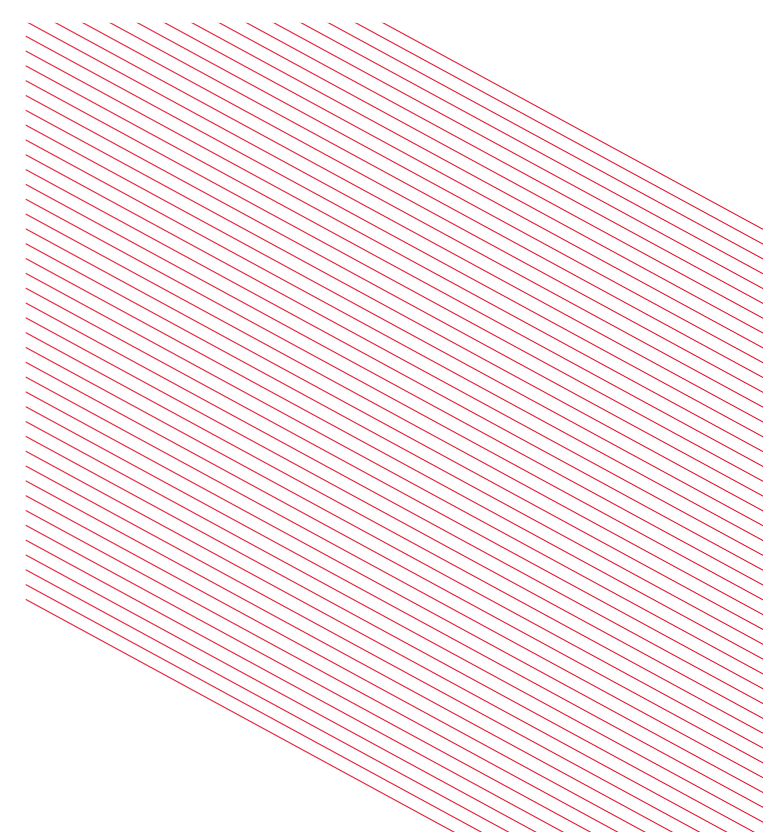

Stratified Wire

# THERMO XCC®

## COPPER CORE, CUZN COATING

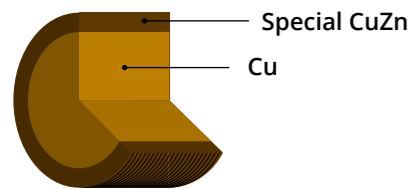

THERMO XCC® has been developed and adjusted for GFMS AgieCharmilles machines to increase the cutting speed.

With a machine equipped with Clean Cut generator, THERMO XCC® can reach a cutting speed superior to 500 mm<sup>2</sup>/min.

It offers a processing speed up to 50% higher than standard brass wire.

THERMO XCC® wire suits particularly for nickel base alloys, for aeronautic production as an example.

It is particularly recommended for large workpiece machining (H > 150 mm) and individual mechanical parts or series. THERMO XCC® is the ultimate solution when the priority is cutting speed.

### USAGE RECOMMENDED

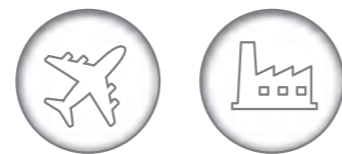

### CHARACTERISTICS

Core	Cu α
Coating	Thick CuZn β
Tensile Strength	500N/mm <sup>2</sup>
Elongation	2%
Conductibility	65% IACS



## WORLDWIDE HIGHEST CUTTING SPEED

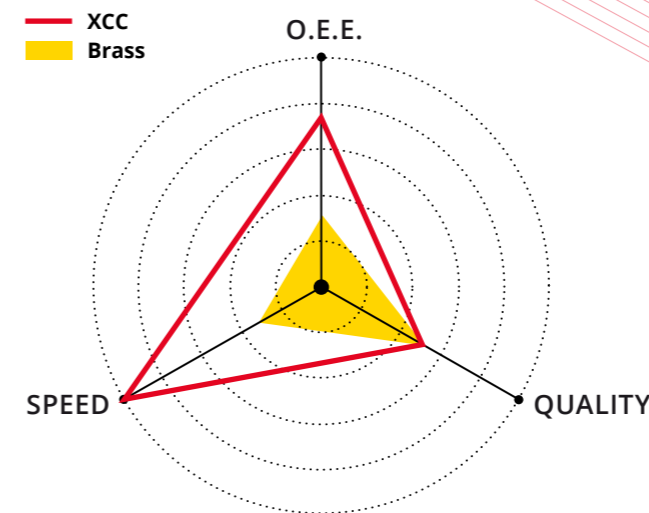

**PATENT RELATED**  
 EP 1 455 981  
 US 7 687 738  
 CN ZL 02 8 25126.1  
 JP 4 516753  
 BR 0 214 599

### AVAILABILITY BY SPOOL TYPE AND DIAMETER

	THERMO XCC	K100	T125	T160	T200	K250	K355
0,25 mm 0.010"	25XCC			■	■	■	■
0,30 mm 0.012"	30XCC			■	■	■	■
0,33 mm 0.013"	33XCC			■	■	■	■

MANUFACTURED IN EUROPE BY THERMOCOMPACT





Stratified Wire

# THERMO TEX®

**COPPER CORE,  
CUZN COATING**

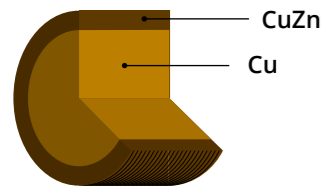

THERMO TEX® is well adapted to GFMS AgieCharmilles and ONA machines, and 100% compatible with the THERMO SWX® technology.

Due to its clean wire surface THERMO TEX® combines a very high level of performance and realistic savings on maintenance of wire EDM machines.

THERMO TEX® is recommended for a wide range of standard applications in the field of molds, tools or general mechanics.

THERMO TEX® wire replaces X wire, fully compatible with its technologies, keeping all the machine parameters. Its cutting speed is up to 35% higher than standard brass and 10% higher than THERMO SWX®.

**USAGE RECOMMENDED**



**CHARACTERISTICS**

Core	Cu α
Coating	CuZn β and Cu <sub>5</sub> Zn <sub>8</sub> γ
Tensile Strength	450N/mm <sup>2</sup>
Elongation	1%
Conductibility	70% IACS



**LATEST GENERATION OF EDM WIRE, CLEANLINESS AND VERY HIGH SPEED CUTTING WITH THE BEST QUALITY/PRICE RATIO**

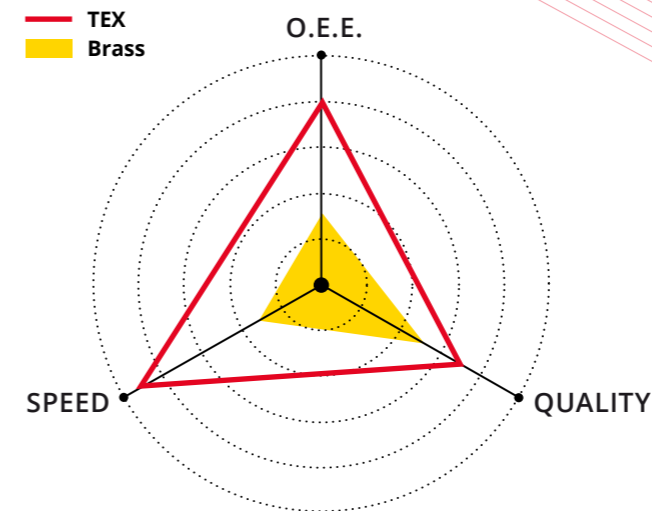

**PATENT RELATED**

EP 1 009 574  
 CA 2 302 202  
 US 5 945 010  
 EP 1 846 189  
 TW i391197  
 CN ZL2006 80004564.6  
 US 8 378 247  
 IN 262 000  
 JP 5 069 134  
 KR 10-1 653 551

**AVAILABILITY BY SPOOL TYPE AND DIAMETER**

	THERMO TEX	K100	T125	T160	T200	K250	K355	JP5
<b>0,25 mm</b> 0.010"	25 TEX		■	■	■	■	■	■
<b>0,30 mm</b> 0.012"	30 TEX		■	■	■	■	■	■

MANUFACTURED IN EUROPE BY THERMOCOMPACT



Stratified Wire

# THERMO SWX®

**COPPER CORE,  
CUZN COATING**

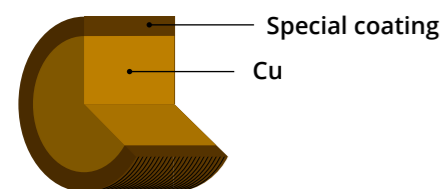

THERMO SWX® is dedicated to GFMS AgieCharmilles Machines Robofil type.

Thanks to its cutting speed, THERMO SWX® reduces the cost of production in the most varied and complex applications.

It is widely used in the field of molds.

The reference wire for GFMS AgieCharmilles and ONA machines. THERMO SWX® is 30% faster than standard brass.

**USAGE RECOMMENDED**



**CHARACTERISTICS**

Core	Cu α
Coating	CuZn β
Tensile Strength	450N/mm <sup>2</sup>
Elongation	1%
Conductibility	80% IACS



**THE ORIGINAL X WIRE  
FOR SPEED, WELL ADAPTED  
FOR GFMS AGIECHARMILLES  
AND ONA MACHINES**

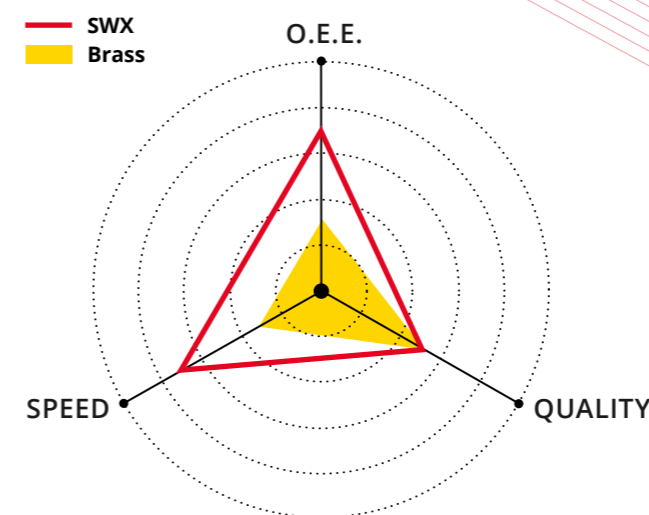

**AVAILABILITY BY SPOOL TYPE AND DIAMETER**

	THERMO SWX	K100	T125	T160	T200	K250	JP5
0,25 mm 0.010"	25X		■	■	■	■	■
0,30 mm 0.012"	30X		■	■	■	■	■

**ALSO AVAILABLE ON DEMAND**

THERMO SW®: The first coated wire available for EDM machines

- THERMO SW® is particularly adapted to the generation of GFMS AgieCharmilles machines having the annealing devices and calibration.
- Cutting speed up to 15% higher than brass wire.

MANUFACTURED IN EUROPE BY THERMOCOMPACT  
MANUFACTURED IN ASIA BY HWA





# HIGH SPEED & PRECISION

## WIRES DEDICATED

THERMO SE®

THERMO SWD®

THERMO SWW®

THERMO D®

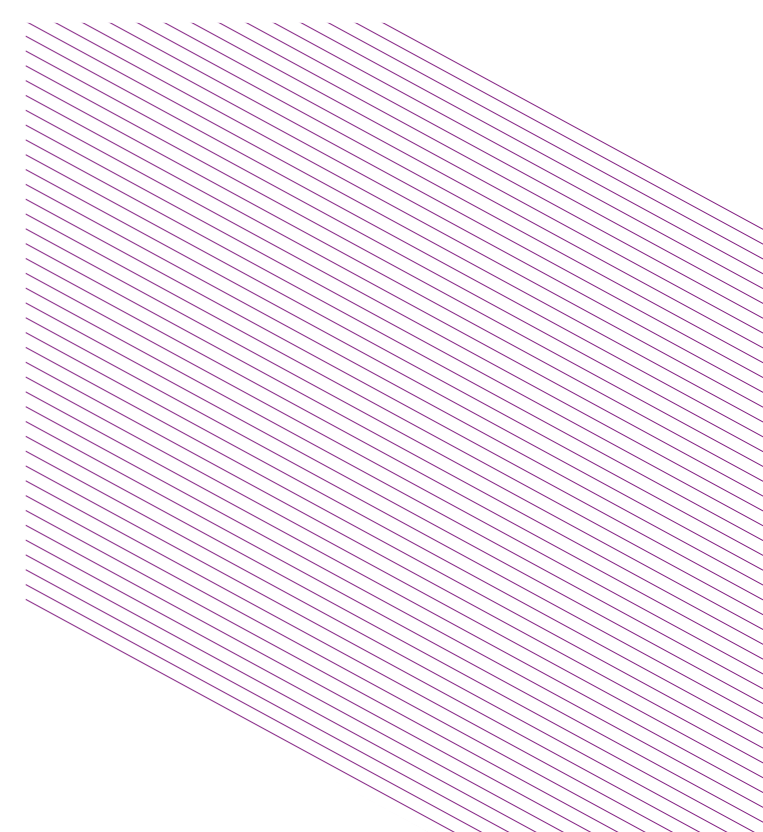

Stratified Wire

# THERMO SE®

## BRASS CORE, CUZN COATING

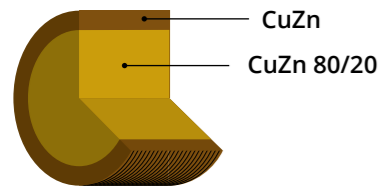

THERMO SE® is suitable for all type of wire EDM machines (GFMS AgieCharmilles, Makino, Vollmer and all Japanese machines).

Highly recommended for all standard applications that require speed and accuracy, particularly in unfavorable flushing conditions.

THERMO SE® is an economical alternative to the use of THERMO SWD®, with superior efficiency.

THERMO SE® offers a processing speed up to 30% higher than a standard brass. The wire surface is extremely clean, reducing machine maintenance. An economical performance with a guaranteed productivity.

### USAGE RECOMMENDED



### CHARACTERISTICS

Core	Brass80/20
Coating	CuZn β and Cu <sub>5</sub> Zn <sub>8</sub> γ
Tensile Strength	750N/mm <sup>2</sup>
Elongation	2%
Conductibility	28% IACS



**HIGH PERFORMANCE, ESPECIALLY RECOMMENDED FOR MACHINING LARGE PARTS (HEIGHT > 100 MM) AND FOR SERIAL MANUFACTURING**

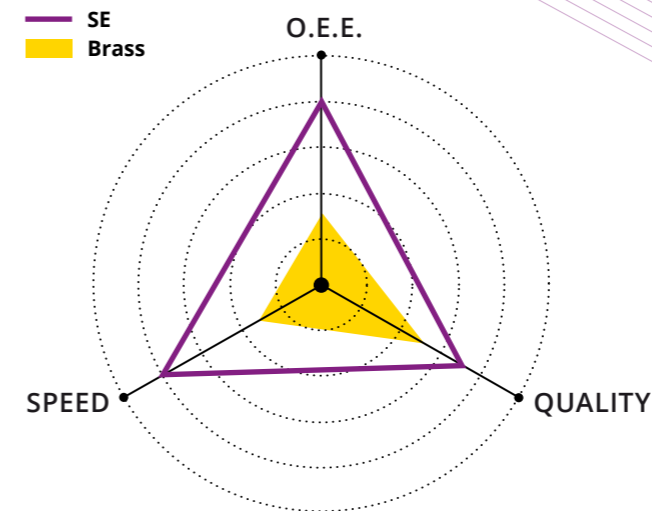

**PATENT RELATED**

EP 1 009 574  
 CA 2 302 202  
 US 5 945 010  
 EP 1 846 189  
 TW i391197  
 CN ZL2006 80004564,6  
 US 8 378 247  
 IN 262 000  
 JP 5 069 134  
 KR 10-1 653 551

### AVAILABILITY BY SPOOL TYPE AND DIAMETER

	THERMO SE	K100	T125	T160	T200	K250	JP5	JP10	JP15
0,20 mm 0.008"	SE			■	■		■	■	■
0,25 mm 0.010"	SE			■	■	■	■	■	■
0,30 mm 0.012"	SE			■	■	■	■	■	■
0,33 mm 0.013"	SE			■	■	■		■	■

MANUFACTURED IN EUROPE BY THERMOCOMPACT



Stratified Wire

# THERMO SWD®

## BRASS CORE, CUZN COATING

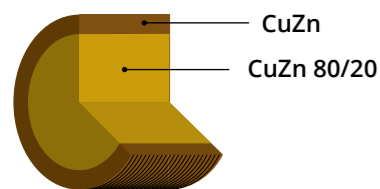

THERMO SWD® offers a processing speed up to 20% higher than a standard brass.

THERMO SWD® is suitable for all EDM machines using automatic threading, particularly adapted for latest Agie generation of GFMS AgieCharmilles and Makino machines.

With high electrical and thermal conductivity, THERMO SWD® is dedicated to machines fitted with powerful generator.

It is particularly recommended for applications that require standard accuracy and speed machining.

### USAGE RECOMMENDED



### CHARACTERISTICS

Core	Brass80/20
Coating	CuZn β
Tensile Strength	850N/mm <sup>2</sup>
Elongation	2%
Conductibility	27% IACS



**RECOMMENDED FOR MACHINING LARGE PARTS WITH HEIGHT > 100 MM**

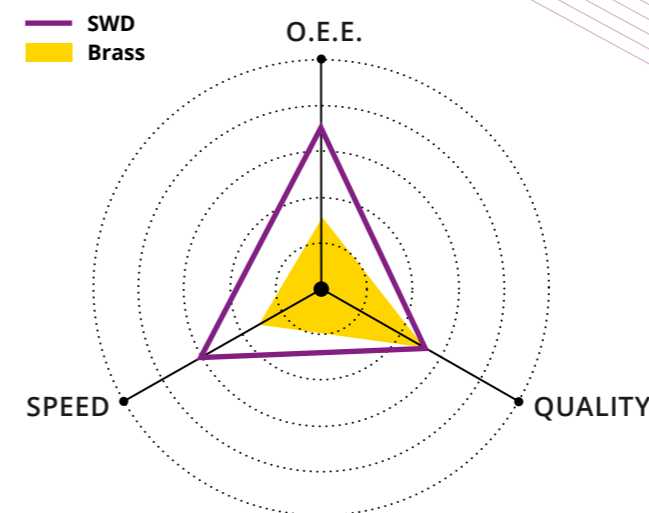

### AVAILABILITY BY SPOOL TYPE AND DIAMETER

THERMO SWD		K100	T125	T160	T200	K250	JP5
0,25 mm 0.010"	SW25D		■	■	■	■	■
0,30 mm 0.012"	SW30D		■	■	■	■	■

MANUFACTURED IN EUROPE BY THERMOCOMPACT

[CLICK HERE FOR MORE INFORMATIONS](#)



Stratified Wire

# THERMO SWW®

## BRASS CORE, CUZN COATING

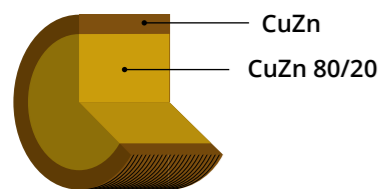

THERMO SWW® offers a processing speed up to 20% higher than a standard brass.

THERMO SWW® is dedicated to machines fitted with powerful generators or the latest generation: IPG (Intelligent Power Generator).

Its 15% elongation characteristic and a high thermal and electrical conductivity allows to cut 45° conical sections with precision.

### USAGE RECOMMENDED



### CHARACTERISTICS

Core	Brass80/20
Coating	CuZn β
Tensile Strength	450N/mm <sup>2</sup>
Elongation	15%
Conductivity	31% IACS



**RECOMMENDED FOR SPEED CUTTING OF TAPERED PARTS UP TO 45°**

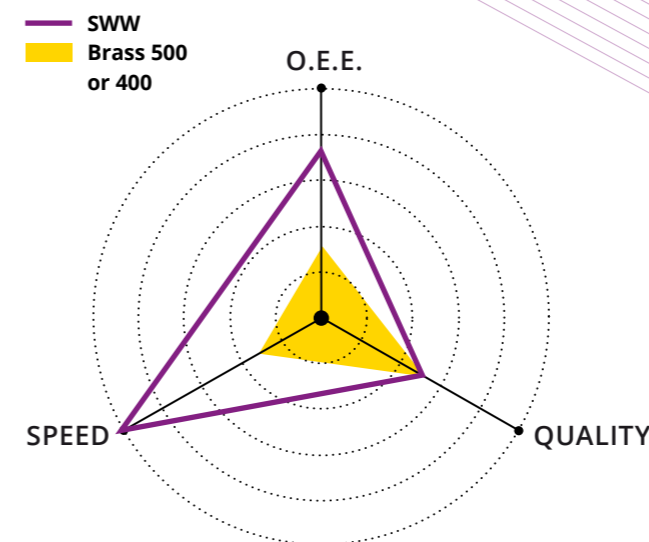

### AVAILABILITY BY SPOOL TYPE AND DIAMETER

THERMO SWW		K100	T125	T160	T200	K250	JP5
0,25 mm 0.010"	SW25W		■	■	■	■	■
0,30 mm 0.012"	SW30W		■	■	■	■	■

MANUFACTURED IN EUROPE BY THERMOCOMPACT

[CLICK HERE FOR MORE INFORMATIONS](#)



Stratified Wire

# THERMO D®

## BRASS CORE, CUZN COATING

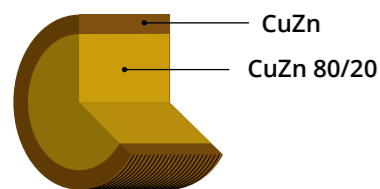

THERMO D® is suitable for all EDM machines using automatic threading, particularly for GFMS AgieCharmilles 100 series and Makino machines.

THERMO D® is recommended for applications that require standard accuracy and speed machining.

Its high speed erosion is up to 20% faster than brass wire due to its high thermal and electrical conductivity.

THERMO D® has the same characteristics than THERMO SWD®. Its innovative manufacturing process allows for a very competitive price.

### USAGE RECOMMENDED



### CHARACTERISTICS

Core	Brass80/20
Coating	CuZn
Tensile Strength	850N/mm <sup>2</sup>
Elongation	2%
Conductibility	27% IACS

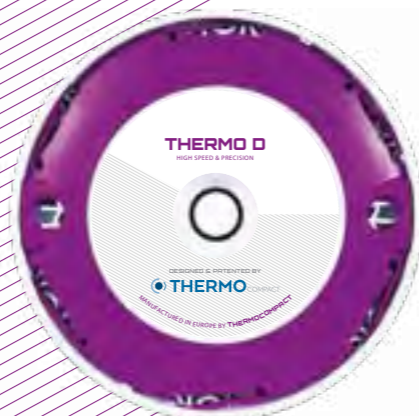

THE ORIGINAL WIRE FOR MACHINES HAVING A POWERFUL GENERATOR

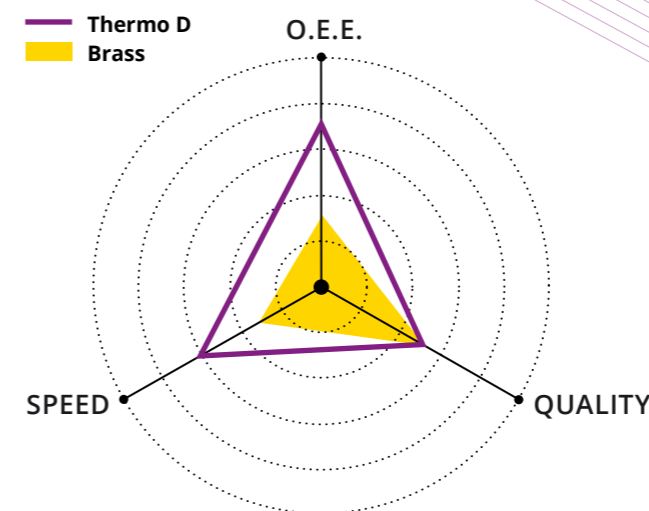

### AVAILABILITY BY SPOOL TYPE AND DIAMETER

	THERMO D	K100	T125	T160	T200	K250	JP5
0,25 mm 0.010"	D 25		■	■	■	■	■
0,30 mm 0.012"	D 30		■	■	■	■	■

MANUFACTURED IN EUROPE BY THERMOCOMPACT

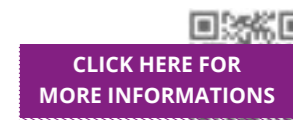

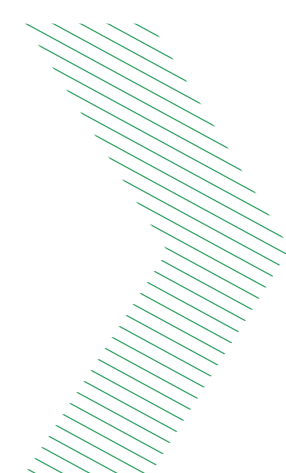

# SPEED & PRECISION

## WIRES DEDICATED

THERMO SD<sup>®</sup>

THERMO SD2<sup>®</sup>

THERMO JP<sup>®</sup>

THERMO JP2<sup>®</sup>

THERMO JP+<sup>®</sup>

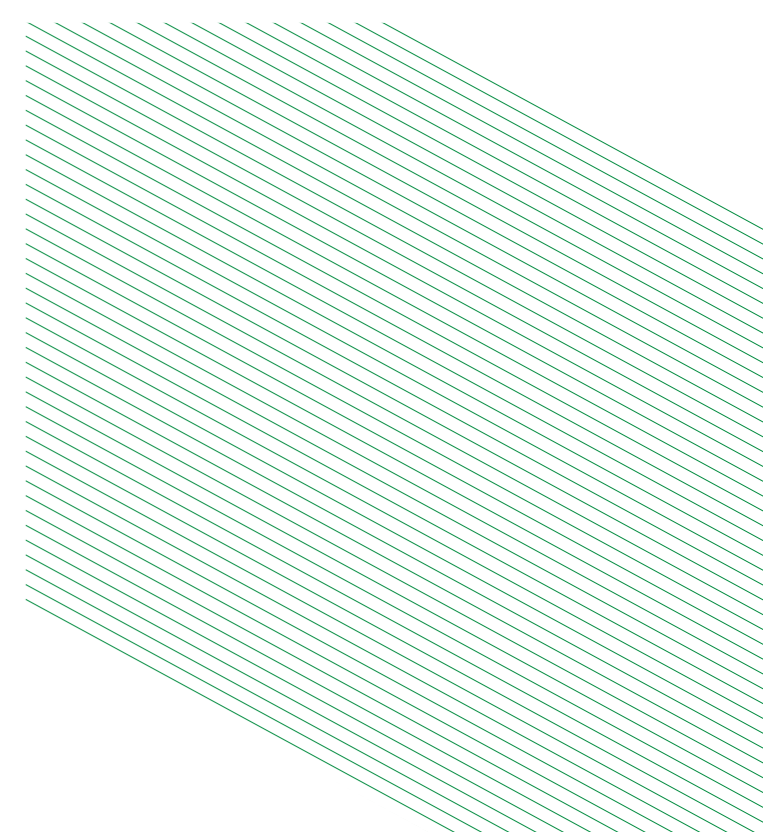



Stratified Wire

# THERMO SD®

**MONOPHASED  $\alpha$  BRASS CORE,  
 $\gamma$   $Cu_5Zn_8$  GAMMA PHASE COATING**

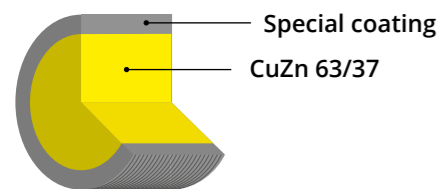

THERMO SD® increases speed and productivity, even with brass technology due to its unique coating.

THERMO SD® has been engineered for the GFMS AgieCharmilles machines. It's universal usage is adapted as well to Japanese machines.

Compared to standard brass:

- › THERMO SD® increases the production of parts up to 20% compared to standard brass.
- › It reduces the machining cost of the production of parts requiring high accuracy and good surface finish.

THERMO SD® is widely used for standard applications in the field of molds, tools or general mechanics.

### USAGE RECOMMENDED



### CHARACTERISTICS

Core	Brass 63/37	
Coating	$\gamma$ $Cu_5Zn_8$	
Tensile Strength	450 N/mm <sup>2</sup>	900 N/mm <sup>2</sup>
Elongation	12%	2%
Conductibility	23% IACS	20% IACS

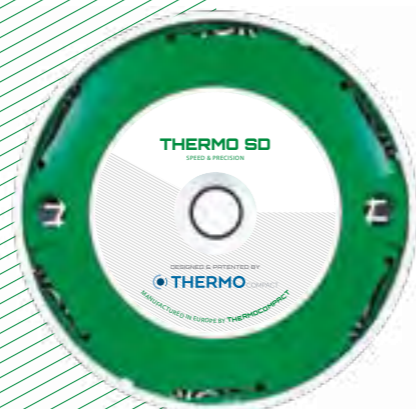

**UNIVERSAL USAGE,  
FOR APPLICATION REQUIRING  
PRECISION IN CUTTING  
WITH GOOD SURFACE FINISH**

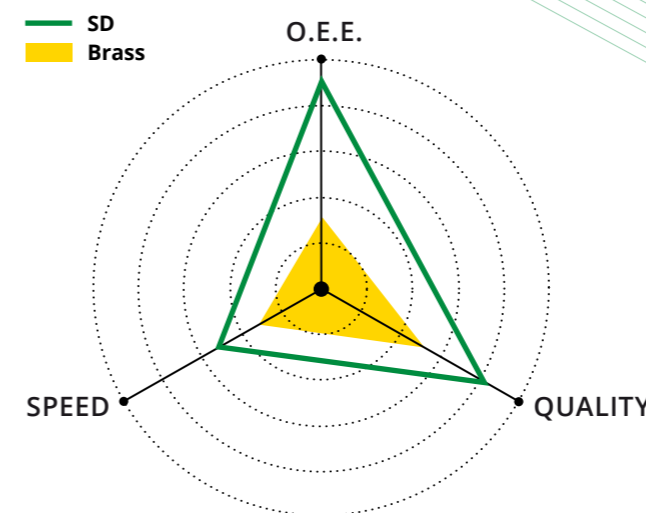

### PATENT RELATED

- (SD 900 and SD 500)
- US 5 945 010
- EP 1 009 574
- CA 2 302 202
- US 8 338 735
- CN ZL 2008 1 000922.7
- TW i 350780
- CN 101 234 442
- JP 5 627 841
- KR 10-0981035
- EP 1 949 995

### AVAILABILITY BY SPOOL TYPE AND DIAMETER

	THERMO SD	K100	T125	T160	T200	K250	K355	JP5	JP10	JP15
<b>0,20 mm</b> 0.008"	SD		■	■	■			■	■	■
<b>0,25 mm</b> 0.010"	SD		■	■	■	■	■	■	■	■
<b>0,30 mm</b> 0.012"	SD		■	■	■	■	■	■	■	■
<b>0,33 mm</b> 0.013"	SD			■	■	■	■		■	■

MANUFACTURED IN EUROPE BY THERMOCOMPACT  
MANUFACTURED IN ASIA BY HWA

[CLICK HERE FOR  
MORE INFORMATIONS](#)



Stratified Wire

# THERMO SD2®

**MONOPHASED  $\alpha$  BRASS CORE,  
DUAL LAYER OF  $\beta$  CUZN AND  $\gamma$  CU<sub>5</sub>ZN<sub>8</sub> COATING**

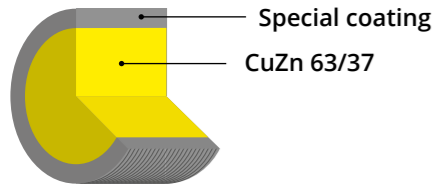

THERMO SD2® is an evolution of THERMO SD® and is the latest generation of EDM wire.

Faster than THERMO SD® due to its special coating, THERMO SD2® provides an excellent price/performance ratio.

THERMO SD2® is recommended for a wide range of standard applications requiring good accuracy and good surface finish.

THERMO SD2® is a new EDM wire developed and made by THERMOCOMPACT. Specific technology on GFMS Cut200, Cut300 and Cut400 machines.

**USAGE RECOMMENDED**

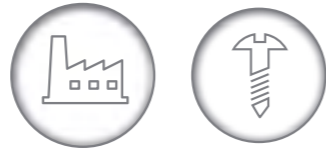

**CHARACTERISTICS**

Core	$\alpha$ Brass 63/37
Coating	$\beta$ CuZn and $\gamma$ Cu <sub>5</sub> Zn <sub>8</sub>
Tensile Strength	>800 N/mm <sup>2</sup>
Elongation	2%
Conductivity	22% IACS

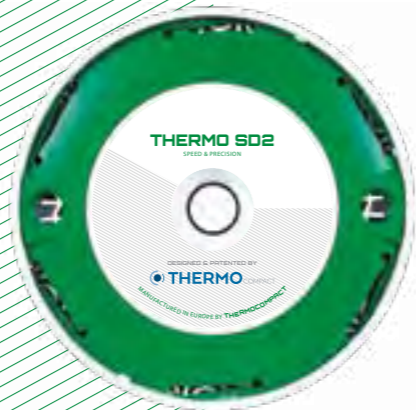

**LATEST GENERATION OF WIRE,  
HIGH SPEED PERFORMANCE  
AND PRECISION IN CUTTING  
FOR HIGH PRODUCTIVITY**

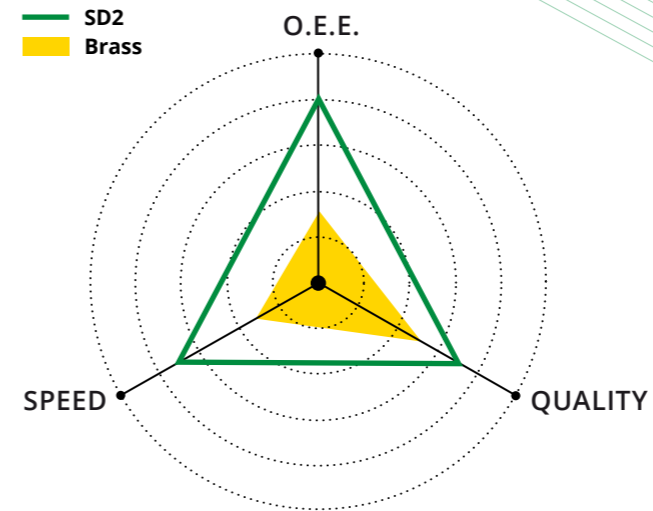

**PATENT RELATED**

EP 1 009 574  
CA 2 302 202  
US 5 945 010  
EP 1 846 189  
TW i391197  
CN ZL2006 80004564,6  
US 8 378 247  
IN 262 000  
JP 5 069 134  
KR 10-1 653 551

**AVAILABILITY BY SPOOL TYPE AND DIAMETER**

	THERMO SD2	K100	T125	T160	T200	K250	JP5	JP10	JP15
<b>0,20 mm</b> 0.008"	SD2		■	■	■		■	■	■
<b>0,25 mm</b> 0.010"	SD2		■	■	■	■	■	■	■
<b>0,30 mm</b> 0.012"	SD2		■	■	■	■	■	■	■

MANUFACTURED IN EUROPE BY THERMOCOMPACT  
MANUFACTURED IN ASIA BY HWA



Stratified Wire

# THERMO JP®

## DUAL PHASE $\alpha + \beta$ BRASS CORE, $\gamma$ $Cu_5Zn_8$ GAMMA PHASE COATING

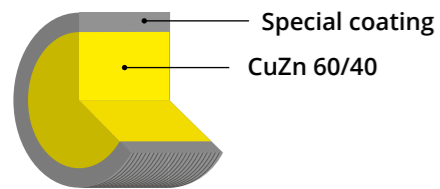

THERMO JP® offers the technology of coated wire optimized for Japanese machines without changing the original parameters.

THERMO JP® is recommended to obtain higher accuracy, coating without flakes and good surface finish.

Its threading is particularly good.

THERMO JP® is widely used for standard application in the field of molds, tools or general mechanics.

THERMO JP® increases speed and productivity, creating more erosion on the work piece and less erosion on the wire. THERMO JP® is optimized for Japanese machines without changing the original parameters of brass wire.

### USAGE RECOMMENDED

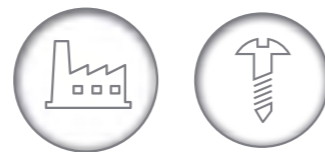

### CHARACTERISTICS

Core	Brass 60/40
Coating	$\gamma$ $Cu_5Zn_8$
Tensile Strength	900 N/mm <sup>2</sup>
Elongation	2%
Conductibility	22% IACS

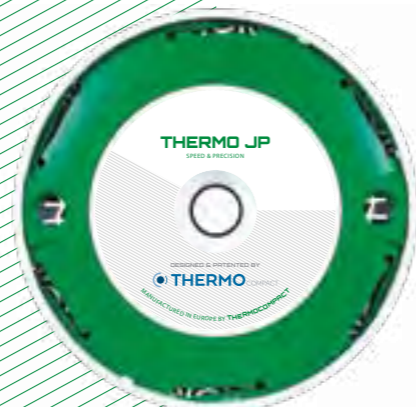

DESIGNED FOR JAPANESE MACHINES, FOR APPLICATION REQUIRING PRECISION IN CUTTING WITH VERY GOOD SURFACE FINISH

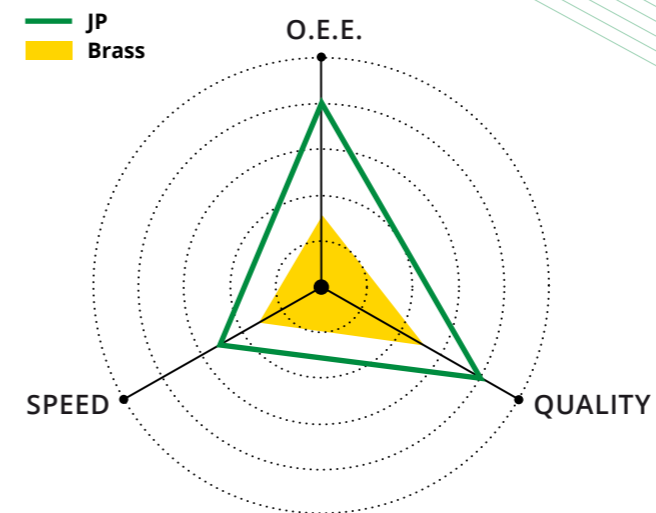

### PATENT RELATED

- US 5 945 010
- EP 1 009 574
- CA 2 302 202
- US 8 338 735
- CN ZL 2008 1 000922.7
- TW i 350780
- CN 101 234 442
- JP 5 627 841
- KR 10-0981035
- EP 1 949 995

### AVAILABILITY BY SPOOL TYPE AND DIAMETER

	THERMO JP	K100	T125	T160	T200	K250	JP5	JP10	JP15
0,20 mm 0.008"	JP		■	■	■		■	■	■
0,25 mm 0.010"	JP		■	■	■	■	■	■	■
0,30 mm 0.012"	JP		■	■	■	■	■	■	■

MANUFACTURED IN EUROPE BY THERMOCOMPACT  
MANUFACTURED IN ASIA BY HWA



Stratified Wire

# THERMO JP2®

## DUAL PHASE $\alpha + \beta$ BRASS CORE, DUAL LAYER OF $\beta$ CUZN AND $\gamma$ $Cu_5Zn_8$ COATING

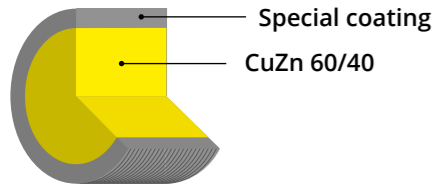

THERMO JP2® is an evolution of THERMO JP®, the latest generation of EDM wire, well adapted to Makino and all Japanese machines type.

Due to its special coating, THERMO JP2® is faster than THERMO JP® and provides an excellent price/performance ratio.

Its threading is particularly good.

THERMO JP2® is recommended for a wide range of standard applications requiring good accuracies and surface finish.

THERMO JP2® is a new EDM wire made by THERMOCOMPACT. THERMO JP2® is optimized for Japanese machines without changing the original parameters of brass wire.

### USAGE RECOMMENDED

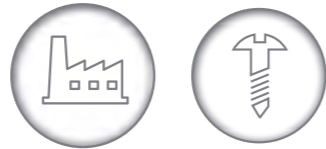

### CHARACTERISTICS

Core	Brass 60/40
Coating	$\beta$ CuZn and $\gamma$ $Cu_5Zn_8$
Tensile Strength	900 N/mm <sup>2</sup>
Elongation	2%
Conductibility	24% IACS

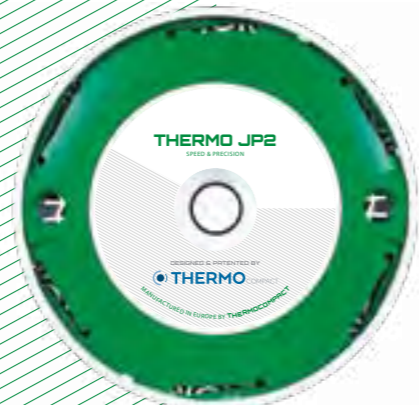

**NEW EDM WIRE, DESIGNED FOR JAPANESE MACHINES, HIGH SPEED PERFORMANCE AND PRECISION IN CUTTING**

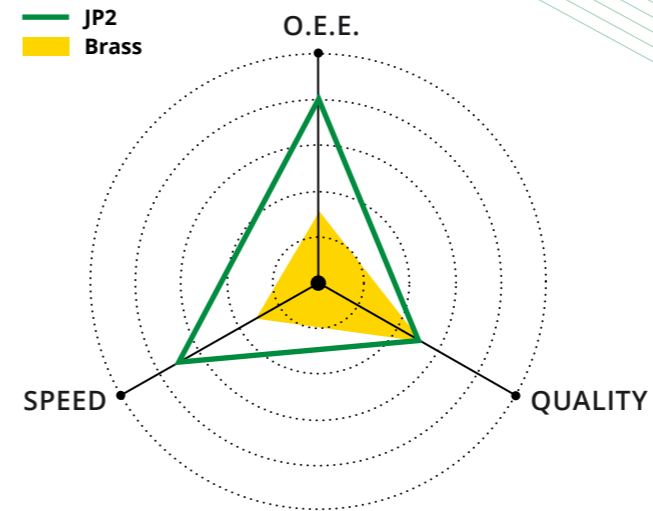

### PATENT RELATED

- EP 1 009 574
- CA 2 302 202
- US 5 945 010
- EP 1 846 189
- TW i391197
- CN ZL2006 80004564,6
- US 8 378 247
- IN 262 000
- JP 5 069 134
- KR 10-1 653 551

### AVAILABILITY BY SPOOL TYPE AND DIAMETER

	THERMO JP2	K100	T125	T160	T200	K250	K355	JP5	JP10	JP15
<b>0,20 mm</b> 0.008"	JP2		■	■	■			■	■	■
<b>0,25 mm</b> 0.010"	JP2		■	■	■	■	■	■	■	■
<b>0,30 mm</b> 0.012"	JP2		■	■	■	■	■	■	■	■

MANUFACTURED IN EUROPE BY THERMOCOMPACT  
MANUFACTURED IN ASIA BY HWA



Stratified Wire

# THERMO JP<sup>+</sup>

**DUAL PHASE  $\alpha + \beta$  BRASS CORE,  $\gamma$   $\text{Cu}_5\text{Zn}_8$  COATING AND NEW SPECIAL COATING**

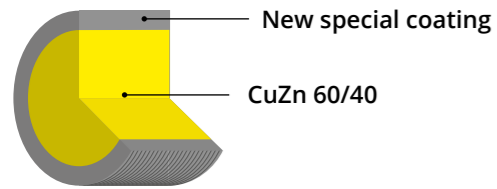

Next generation of EDM wire, THERMO JP<sup>+</sup> is a very good polyvalent EDM wire whatever the technology or the machine. Its cleanliness is remarkable.

THERMO JP<sup>+</sup> is a new EDM wire : Its auto-threading ability is highly reliable. THERMO JP<sup>+</sup> allows a very high level of cleanliness.

Its surface finish is exceptional (Ra= 0,2  $\mu\text{m}$ )

THERMO JP<sup>+</sup> is the excellent alternative to a brass wire for high productivity.

### USAGE RECOMMENDED



### CHARACTERISTICS

Core	Brass 60/40
Coating	$\gamma$ $\text{Cu}_5\text{Zn}_8$ and new special coating
Tensile Strength	>900 N/mm <sup>2</sup>
Elongation	2%
Conductibility	22% IACS

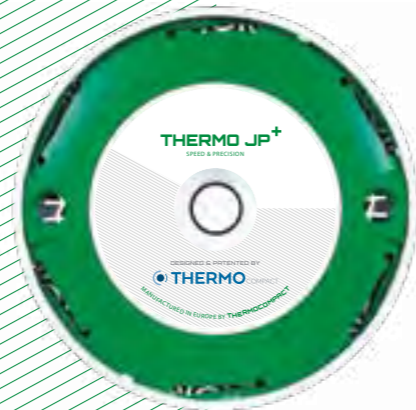

**LATEST INNOVATION WITH A SPECIAL COATING: EXTREMELY HIGH AUTO-THREADING RELIABILITY. DEDICATED TO JAPANESE MACHINES**

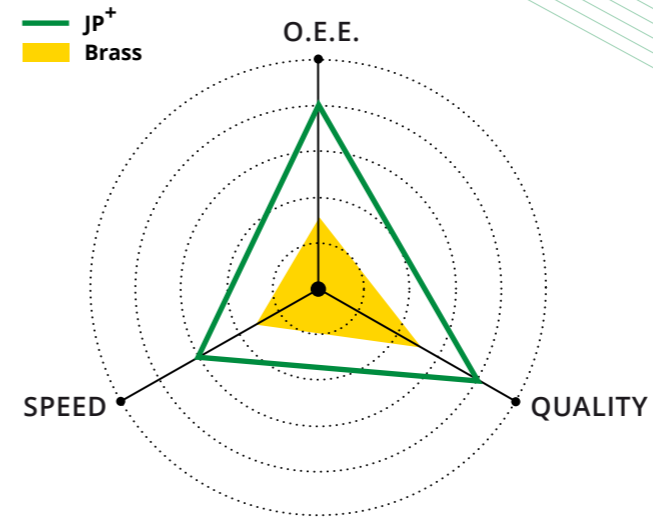

**PATENT RELATED**  
 US 8067 689  
 F 856118

### AVAILABILITY BY SPOOL TYPE AND DIAMETER

	THERMO JP <sup>+</sup>	T125	T160	T200	K250	JP5	JP10	JP15
0,20 mm 0.008"	JP <sup>+</sup>	■	■	■		■	■	■
0,25 mm 0.010"	JP <sup>+</sup>	■	■	■	■	■	■	■
0,30 mm 0.012"	JP <sup>+</sup>	■	■	■	■	■	■	■

MANUFACTURED IN EUROPE BY THERMOCOMPACT  
 MANUFACTURED IN ASIA BY HWA



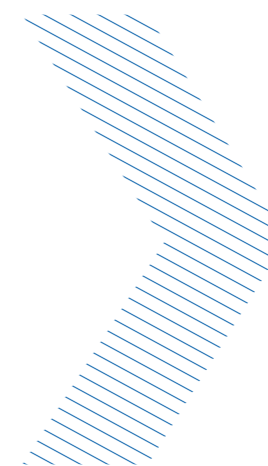
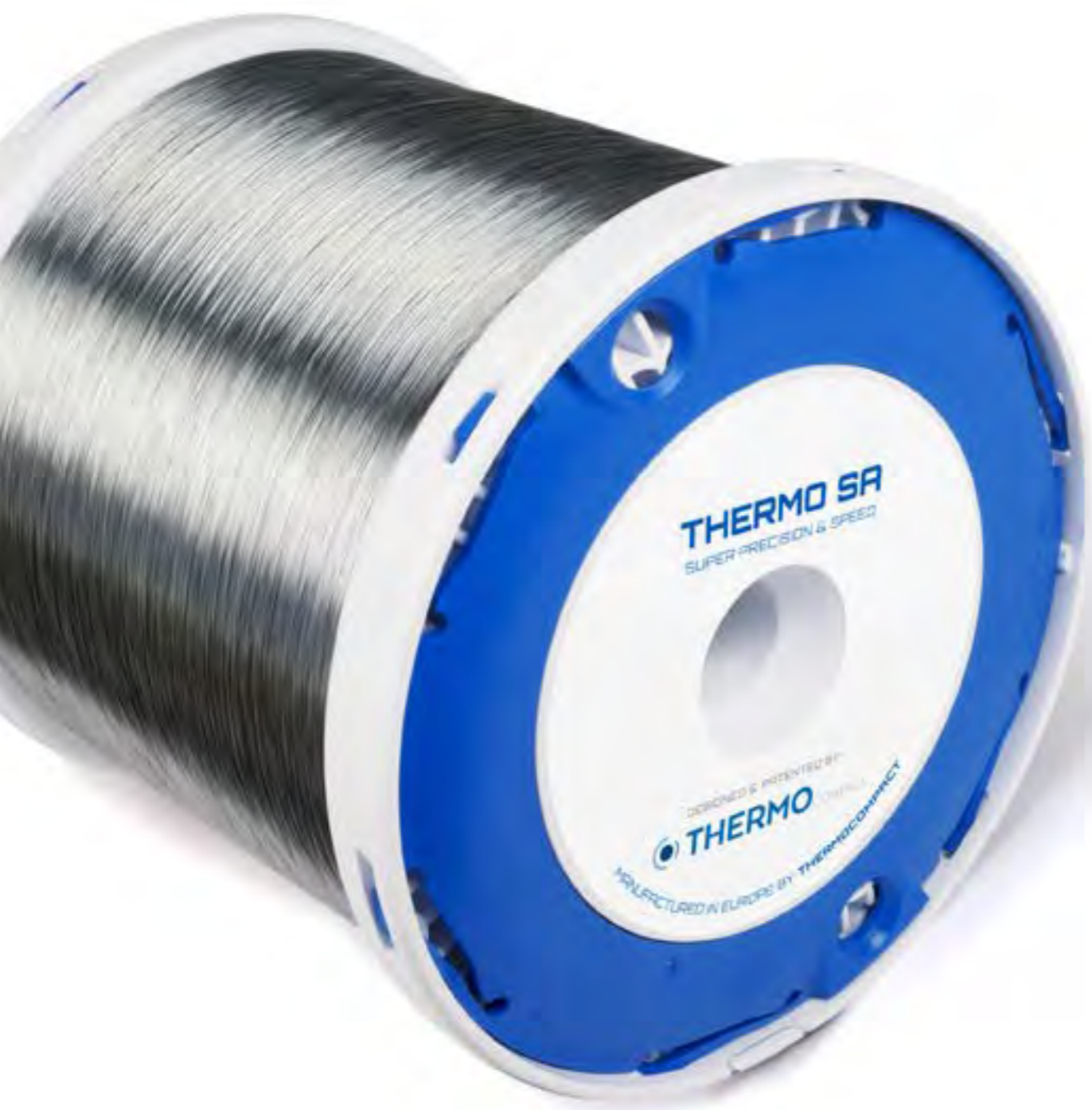

# SUPER PRECISION & SPEED

## WIRES DEDICATED

THERMO SA<sup>+</sup>®

THERMO SA®

THERMO SWA®

THERMO SWS®

THERMO A®

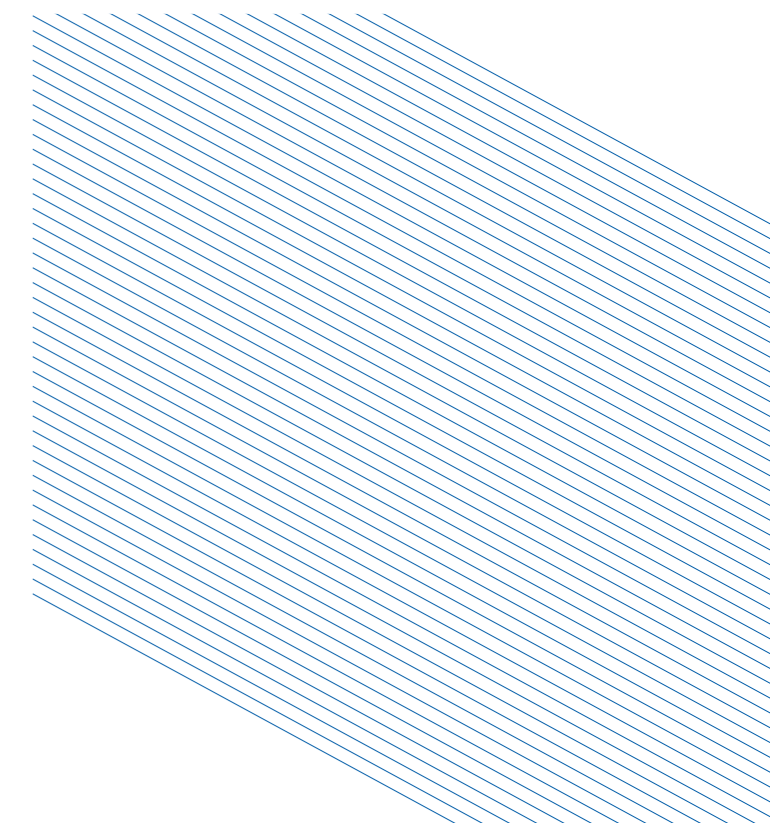

Stratified Wire

# THERMO SA<sup>+</sup>

**MONOPHASED  $\alpha$  BRASS CORE,  
PATENTED  $\gamma$  PHASE COATING  
AND NEW SPECIAL COATING**

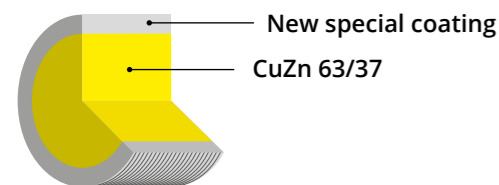

THERMO SA<sup>+</sup> is highly recommended for EDM machines from GFMS AgieCharmilles.

THERMO SA<sup>+</sup> allows the combination of high machining speed (main cut : more than 5% compared to THERMO SA<sup>®</sup>) and a very clean finish along the cut surfaces (Ra = 0,05  $\mu$ m in carbide).

High degree of cleanliness.

Next generation of EDM wire, THERMO SA<sup>+</sup> is particularly suited for carbide cutting.

**USAGE RECOMMENDED**



**LATEST INNOVATION WITH  
A SPECIAL COATING  
FOR EXTREME PRECISION  
AND SPEED**

**PATENT PENDING**



**CARBIDE CUT**

**CHARACTERISTICS**

Core	Brass 63/37
Coating	$\gamma$ Cu <sub>5</sub> Zn <sub>8</sub> and new special coating
Tensile Strength	900 N/mm <sup>2</sup>
Elongation	2%
Conductibility	21% IACS

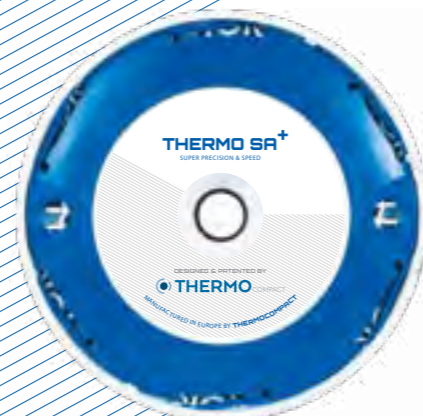

**SPOOLS:  
AVAILABLE SOON**

MANUFACTURED IN EUROPE BY THERMOCOMPACT



Stratified Wire

# THERMO SA®

## MONOPHASED $\alpha$ BRASS CORE, PATENTED $\gamma$ PHASE COATING

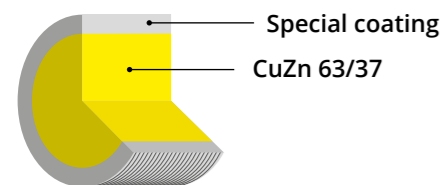

Highest stability and accuracy, excellent surface finish. Dedicated technology on GFMS Cut 2000 and Cut 3000 machines.

THERMO SA® is a selected coating for excellent precision and surface finish. It is highly recommended for the latest generation of EDM machines from GFMS AgieCharmilles.

THERMO SA® has a special coating that allows high machining speed, and a very clean finish along the cut surfaces (Ra = 0,05  $\mu$ m in carbide).

Combined to a powerful generator, THERMO SA® can reduce up to 20% the costs of machined parts.

Particularly suitable for extremely fine precision cuts and for steel or carbide cutting plates.

### USAGE RECOMMENDED



### CHARACTERISTICS

Core	Brass 63/37
Coating	$\gamma$ Cu <sub>5</sub> Zn <sub>8</sub>
Tensile Strength	900 N/mm <sup>2</sup>
Elongation	2%
Conductibility	21% IACS

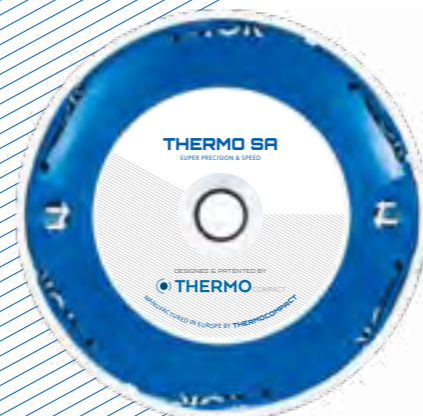

## THE MARKET REFERENCE FOR SURFACE FINISH AND PRECISION

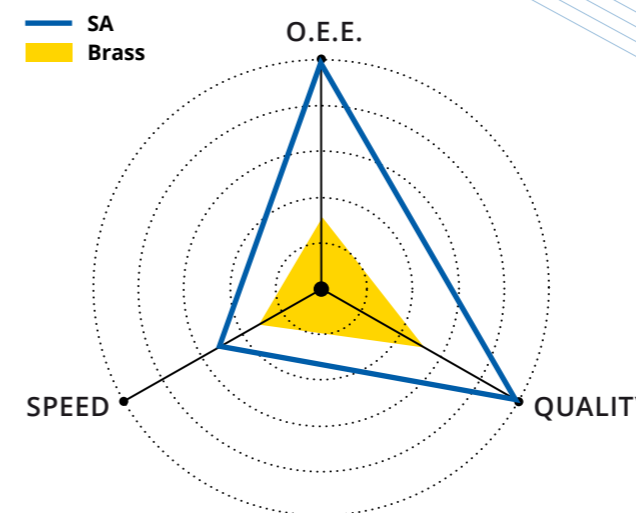

**PATENT RELATED**

EP 1 009 574  
 US 5 945 010  
 EP 1 949 995  
 US 8 338 735  
 CN ZL 2008 1 0009227.7  
 TW i350780  
 CN 101 234 442  
 JP 5 627 841  
 KR 10-0981035

### AVAILABILITY BY SPOOL TYPE AND DIAMETER

	THERMO SA 900 / 500 / 400	K100	T125	T160	T200	K250	JP5	JP10	JP15
0,07 mm 0.003"	900	■							
0,10 mm 0.004"	900	■	■						
0,127 mm 0.005"	900		■	■			■		
0,15 mm 0.006"	900		■	■			■		
0,20 mm 0.008"	900 / 500 / 400		■	■	■		■	■	■
0,25 mm 0.010"	900 / 500 / 400		■	■	■	■	■	■	■
0,30 mm 0.012"	900 / 500 / 400			■	■	■		■	■

MANUFACTURED IN EUROPE BY THERMOCOMPACT

[CLICK HERE FOR MORE INFORMATIONS](#)





Stratified Wire

# THERMO SA 500®

**MONOPHASED  $\alpha$  BRASS CORE, PATENTED  $\beta + \gamma$  PHASE COATING**

### CHARACTERISTICS

Core	Brass 63/37
Coating	$\beta$ CuZn and $\gamma$ Cu <sub>5</sub> Zn <sub>8</sub>
Tensile Strength	500 N/mm <sup>2</sup>
Elongation	20%
Conductibility	25% IACS

Due to its special surface coating and its quality, **THERMO SA 500®** combines a perfect surface finish and an excellent productivity in unfavorable machining conditions. **THERMO SA 500®** is particularly suitable for tapered cuts up to 15°.

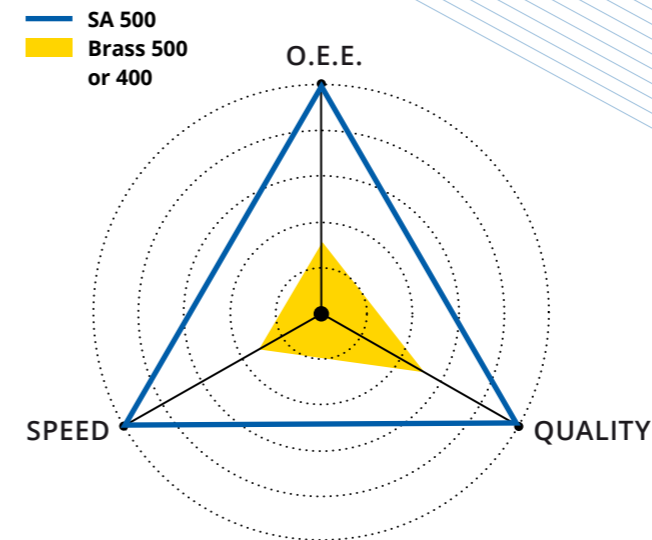

**THE PERFECT WIRE FOR TAPERED CUTTING: HIGH PRECISION AND CLEAN FINISH, RECOMMENDED FOR AGIE CUT200, CUT300 AND CUT400 MACHINES**

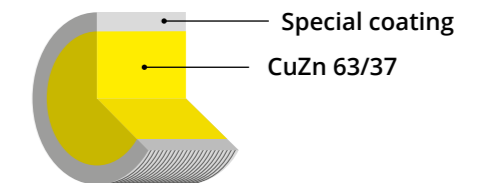
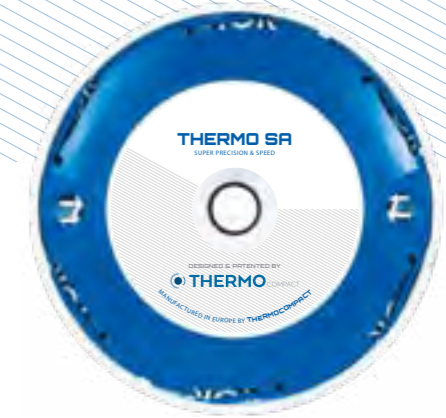

# THERMO SA 400®

**MONOPHASED  $\alpha$  BRASS CORE, PATENTED  $\beta + \gamma$  PHASE COATING**

### CHARACTERISTICS

Core	Brass 63/37
Coating	$\beta$ CuZn and $\gamma$ Cu <sub>5</sub> Zn <sub>8</sub>
Tensile Strength	400 N/mm <sup>2</sup>
Elongation	30%
Conductibility	26% IACS

**THERMO SA 400®**, with its special surface coating and its quality, is particularly suitable for tapered cuts up to 45° with appropriate wire guides and software.

For the new generation of EDM machines, **THERMO SA 400®** is a good alternative to the **THERMO SWW®**, for more cleanliness and precision.

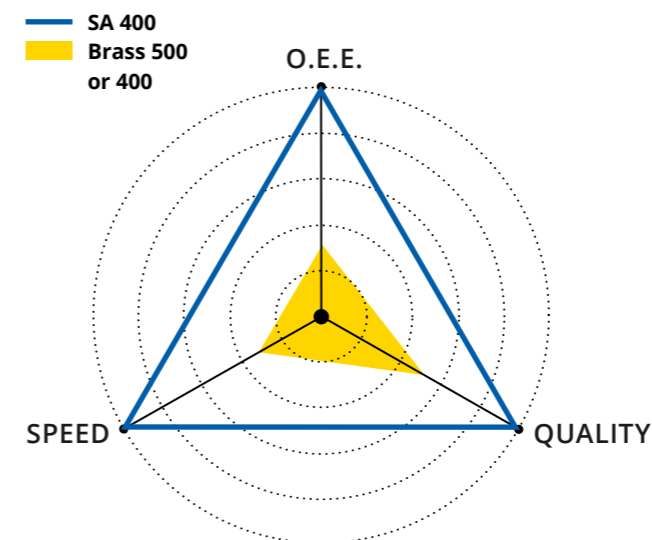

**PATENT RELATED**

- EP 1 009 574
- US 5 945 010
- EP 1 949 995
- US 8 338 735
- CN ZL 2008 1 0009227.7
- TW i350780
- KR 10-1 653 551

**USAGE RECOMMENDED**



MANUFACTURED IN EUROPE BY THERMOCOMPACT  
 MANUFACTURED IN EUROPE  
[CLICK HERE FOR MORE INFORMATIONS](#)



Stratified Wire

# THERMO SWA®

## BRASS CORE, ZINC COATING

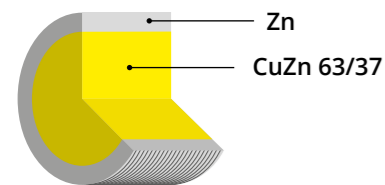

Highly proven reliability during machining, THERMO SWA® is suitable for automatic threading.

### USAGE RECOMMENDED



THERMO SWA® has an excellent straightness and a zinc coating of very high purity.

It obtains high geometric precision and a perfect finish of the machined parts.

THERMO SWA® is recommended for a large range of standard applications: manufacture of molds, cutting tools, mechanical works requiring extreme accuracy and excellent quality of surface cutting (Ra = 0,10 µm in steel).

THERMO SWA® has a low brass contamination of the part with reduced risk of corrosion in water dielectric, especially for H13 steel and tungsten carbide.

### CHARACTERISTICS

Core	Brass 63/37
Coating	Zinc
Tensile Strength	900 N/mm <sup>2</sup>
Elongation	1.5%
Conductibility	22% IACS

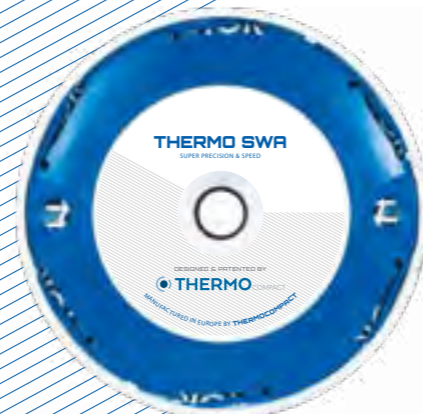

THE REFERENCE FOR MACHINING WITH EXCELLENT SURFACE FINISH, REDUCED RISK OF CORROSION FOR THE PART

**PATENT RELATED**  
EP 1 379 353  
US 8 519 294

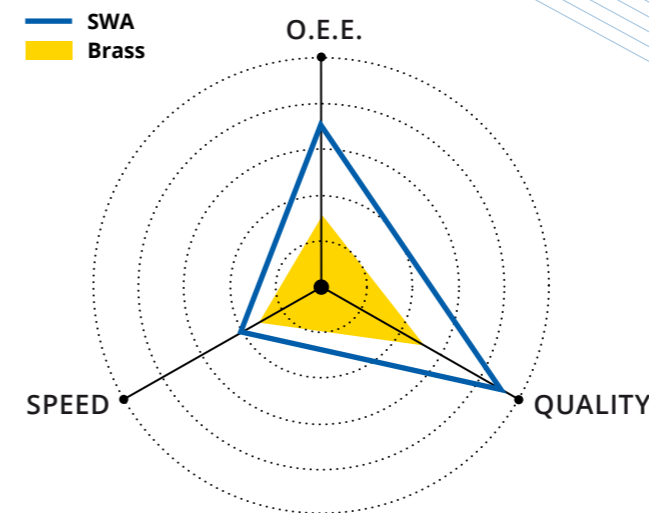

### AVAILABILITY BY SPOOL TYPE AND DIAMETER

	THERMO SWA	K100	T125	T160	T200	K250	JP5	JP10	JP15
0,07 mm 0.003"	SW07A	■							
0,10 mm 0.004"	SW10A	■	■						
0,127 mm 0.005"	SW0127A		■	■			■		
0,15 mm 0.006"	SW015A		■	■			■		
0,20 mm 0.008"	SW20A		■	■	■	■	■	■	■
0,25 mm 0.010"	SW25A		■	■	■	■	■	■	■
0,30 mm 0.012"	SW30A		■	■	■	■	■	■	■

MANUFACTURED IN EUROPE BY THERMOCOMPACT

 [CLICK HERE FOR MORE INFORMATIONS](#)

Stratified Wire

# THERMO SWS®

## BRASS CORE, ZINC COATING

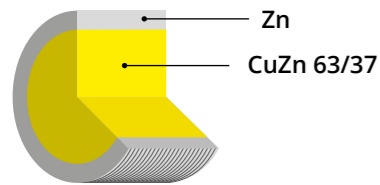

Its technical characteristics provide homogeneity and high level of surface quality in all machining conditions.

THERMO SWS® has a high elongation coefficient, a zinc coating of very high purity and is suitable for automatic threading.

Due to its superior conductivity, THERMO SWS® is recommended for conical tapered cutting.

It obtains high precision in machining complex parts with an angle of more than 7° and below 15°. It provides excellent surface finish in unfavorable conditions.

### USAGE RECOMMENDED



### CHARACTERISTICS

Core	Brass 63/37
Coating	Zinc
Tensile Strength	450 N/mm <sup>2</sup>
Elongation	15%
Conductivity	25% IACS

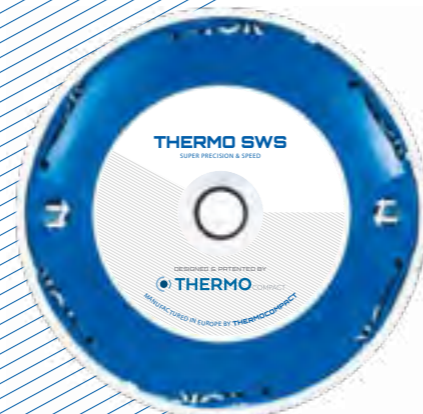

**HOMOGENEITY, HIGH QUALITY, SUITABLE FOR TAPER CUTS OF ANGLES ABOVE 7° AND BELOW 15°**

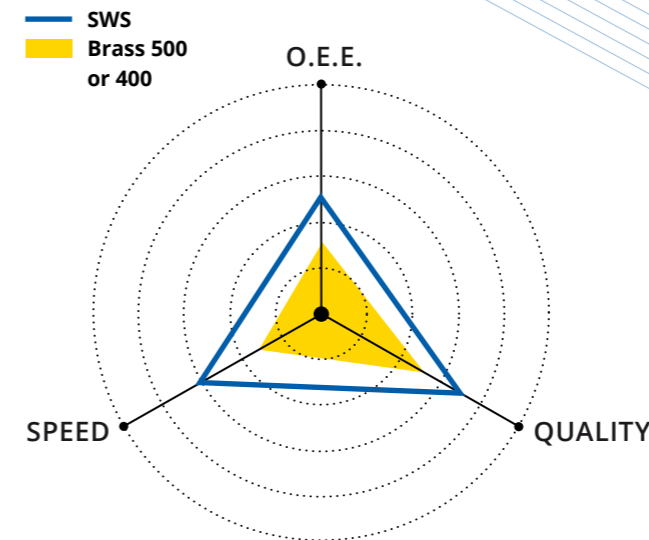

### PATENT RELATED

EP 1 379 353  
US 8 519 294

### AVAILABILITY BY SPOOL TYPE AND DIAMETER

	THERMO SWS	K100	T125	T160	T200	K250	JP5	JP10	JP15
0,20 mm 0.008"	SW20A		■	■	■		■	■	■
0,25 mm 0.010"	SW25A		■	■	■	■	■	■	■
0,30 mm 0.012"	SW30A		■	■	■	■	■	■	■

MANUFACTURED IN EUROPE BY THERMOCOMPACT

[CLICK HERE FOR MORE INFORMATION](#)



Stratified Wire

# THERMO A®

## BRASS CORE, ZINC COATING

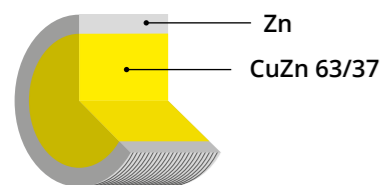

THERMO A® was developed to meet the highest demands of users wire EDM machines. It is suitable for almost all EDM machines.

THERMO A® offers a very competitive price without compromising performance on precision, surface quality and threading.

THERMO A® is recommended for a wide range of standard applications: manufacture of molds, cutting tools, mechanical works requiring extreme accuracy and excellent surface quality finish.

THERMO A® is a coated brass which provides a high performance with a very competitive price. THERMO A® obtains an exceptional surface finish: Ra = 0.15 µm.

### USAGE RECOMMENDED



### CHARACTERISTICS

Core	Brass 63/37
Coating	Zinc
Tensile Strength	900 N/mm <sup>2</sup>
Elongation	1.5%
Conductibility	22% IACS

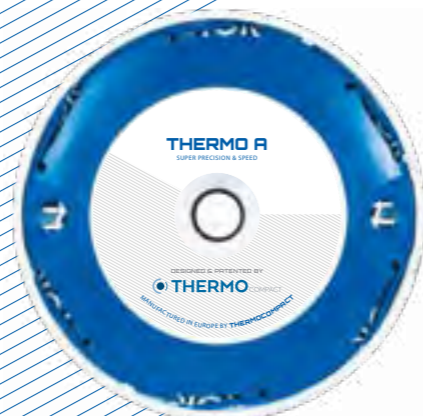

**SELECTED COATING,  
VERY GOOD SURFACE FINISH  
AND ACCURACY**

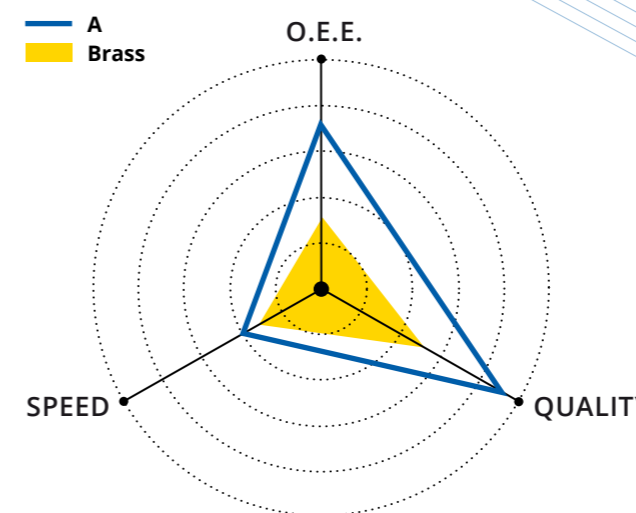

**PATENT RELATED**  
EP 1 379 353  
US 8 519 294

### AVAILABILITY BY SPOOL TYPE AND DIAMETER

	THERMO A	K100	T125	T160	T200	K250	JP5	JP10	JP15
0,20 mm 0.008"	A20			■	■	■	■	■	■
0,25 mm 0.010"	A25			■	■	■	■	■	■
0,30 mm 0.012"	A30			■	■	■	■	■	■

MANUFACTURED IN EUROPE BY THERMOCOMPACT  
MANUFACTURED IN ASIA BY HWA

 [CLICK HERE FOR MORE INFORMATIONS](#)



# ALL PURPOSE

## WIRES DEDICATED

THERMO brass 1000<sup>®</sup>

THERMO brass 900<sup>®</sup>

THERMO brass 500<sup>®</sup>

THERMO brass 400<sup>®</sup>

THERMO First 900 and 500<sup>®</sup>

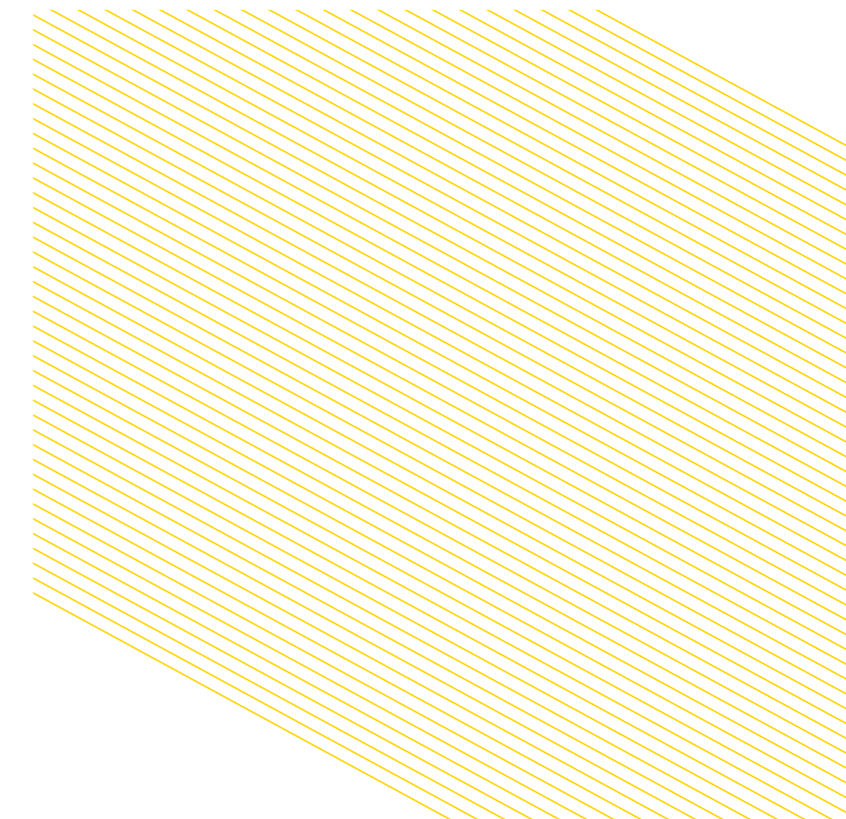

Brass Wire

# THERMO brass 1000®

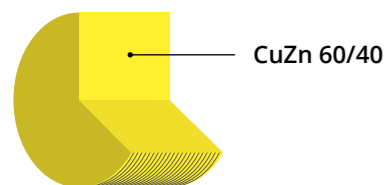

Due to its specific alloy, THERMO brass 1000® is recommended in particular for Fanuc, Mitsubishi, Hitachi and Sodick type machines.

THERMO brass 1000® N/mm<sup>2</sup> is suitable for all EDM machines, and recommended for Japanese machines.

THERMO brass 1000® is produced with a very pure alloy, and provides an excellent surface quality and an ongoing performance.

THERMO brass 1000® is recommended for standard applications. It can produce high precision parts with excellent surface finish due to its very good geometry and its cleanliness.

### USAGE RECOMMENDED



**PURE 60/40 ALLOY,  
HIGH SURFACE QUALITY,  
HIGH CLEANLINESS,  
HIGH PRECISION PARTS**

### AVAILABILITY BY SPOOL TYPE AND DIAMETER

THERMO BRASS 1000		K100	T125	T160	T200	K250	JP5	JP10	JP15
<b>0,20 mm</b> 0.008"	TB 1000			■	■		■	■	■
<b>0,25 mm</b> 0.010"	TB 1000			■	■		■	■	■
<b>0,30 mm</b> 0.012"	TB 1000			■	■		■	■	■

*Other type of spools available only on special request.*

### CHARACTERISTICS

Core	Brass 60/40
Tensile Strength	1050 N/mm <sup>2</sup>
Elongation	2.5%
Conductibility	22% IACS



MANUFACTURED IN EUROPE BY THERMOCOMPACT

**CLICK HERE FOR  
MORE INFORMATIONS**



Brass Wire

# THERMO brass 900®

### CHARACTERISTICS

Core	Brass 63/37 - Brass 60/40
Tensile Strength	900 N/mm <sup>2</sup>
Elongation	1.5%
Conductibility	22% IACS

THERMO brass 900® N/mm<sup>2</sup> is suitable for all type of EDM machines.

THERMO brass 900® is recommended for standard applications requiring extreme accuracy and a good surface finish.

### USAGE RECOMMENDED



# THERMO brass 500®

### CHARACTERISTICS

Core	Brass 63/37
Tensile Strength	500 N/mm <sup>2</sup>
Elongation	20%
Conductibility	25% IACS

THERMO brass 500® N/mm<sup>2</sup> is suitable for all type of EDM machines. It is recommended for standard applications for machining complex parts requiring high taper angle cutting of the wire up to 12°.

### USAGE RECOMMENDED

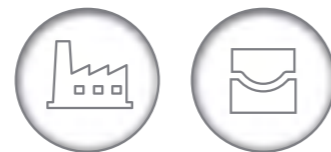

**HIGH GRADE OF 63/37 ALLOY  
RECOMMENDED FOR ALL TYPE  
OF EDM MACHINES**

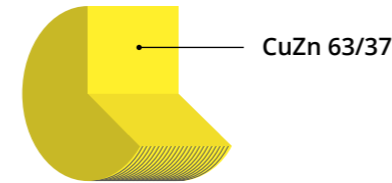

# THERMO brass 400®

### CHARACTERISTICS

Core	Brass 63/37
Tensile Strength	450 N/mm <sup>2</sup>
Elongation	25%
Conductibility	26% IACS

THERMO brass 400® is suitable for all type of EDM machines.

THERMO brass 400® N/mm<sup>2</sup> is recommended for machining complex parts that require high taper angle cutting of the wire up to 20°.

### USAGE RECOMMENDED

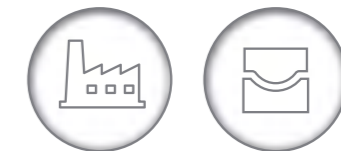

### AVAILABILITY BY SPOOL TYPE AND DIAMETER

THERMO BRASS 900 / 500 / 400	K100	T125	T160	T200	K250	K355	JP5	JP10	JP15
0,10 mm 0.004"	900	■	■						
0,15 mm 0.006"	900		■	■			■		
0,20 mm 0.008"	900, 500, 400		■	■	■	■	■	■	■
0,25 mm 0.010"	900, 500, 400		■	■	■	■	■	■	■
0,30 mm 0.012"	900, 500, 400		■	■	■	■	■	■	■

MANUFACTURED IN EUROPE BY THERMOCOMPACT  
MANUFACTURED IN ASIA BY HWA

[CLICK HERE FOR  
MORE INFORMATION](#)



Brass Wire

# THERMO First 900®

THERMO First 900® is developed with full automatic production process.

**CHARACTERISTICS**

Core	Brass 63/37
Tensile Strength	900 N/mm <sup>2</sup>
Elongation	1.5%
Conductibility	22% IACS

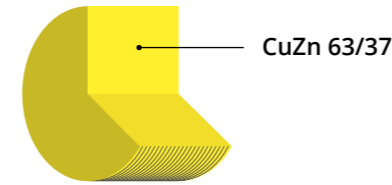

**STANDARD BRASS WIRE,  
WITH A COMPETITIVE PRICE**

THERMO First 900® and THERMO First 500® offer the benefits of a brass wire associating quality and competitive prices. They are recommended for standard applications.

**USAGE RECOMMENDED**



# THERMO First 500®

THERMO First 500® is developed with full automatic production process.

**CHARACTERISTICS**

Core	Brass 63/37
Tensile Strength	500 N/mm <sup>2</sup>
Elongation	1.5%
Conductibility	22% IACS



**AVAILABILITY BY SPOOL TYPE AND DIAMETER**

THERMO FIRST 900 - 500		K100	T125	T160	T200	K250	K355	JP5	JP10	JP15
<b>0,20 mm</b> 0.008"	First 900 First 500			■	■			■	■	
<b>0,25 mm</b> 0.010"	First 900 First 500			■	■		■	■	■	
<b>0,30 mm</b> 0.012"	First 900 First 500			■	■		■	■	■	







# ZINC FREE

## WIRES DEDICATED

THERMO ZF<sup>®</sup>

THERMO ZF<sup>+</sup><sup>®</sup>

THERMO ZF sigma<sup>®</sup>

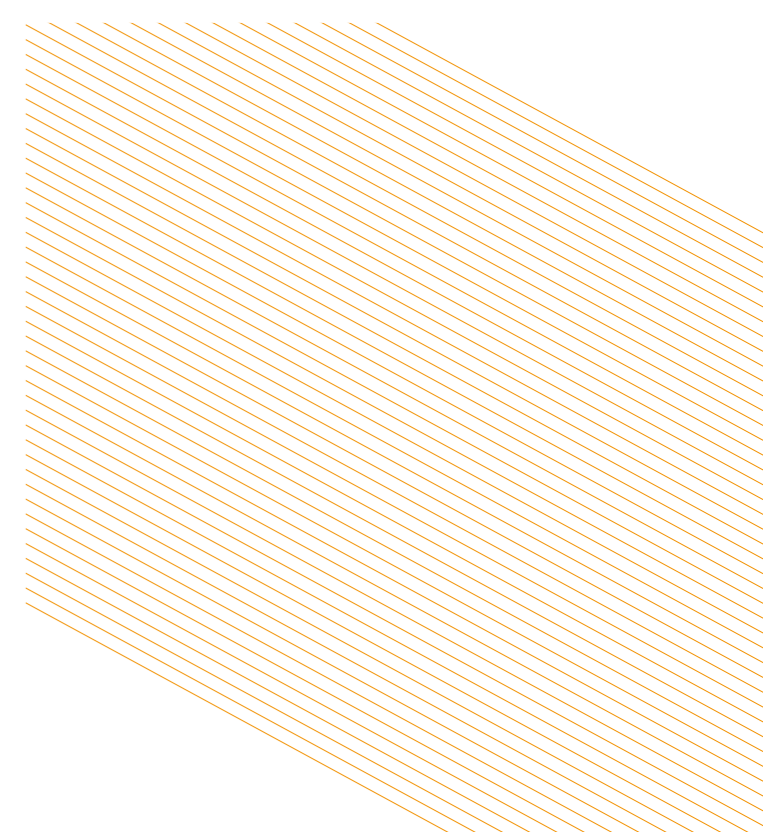

Zinc free Wire

# THERMO ZF®

## PLAIN COPPER

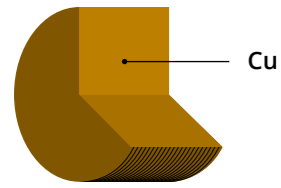

Convenient for all machining usage  
THERMO ZF® is particularly recommended for the cutting of nickel-based alloy.

THERMO ZF® is a new EDM wire, free of zinc. Recommended especially when no zinc deposit is mandatory.

The THERMO ZF® wire is an economically priced wire.

### USAGE RECOMMENDED



### CHARACTERISTICS

Material	Cu 100%
Tensile Strength	500N/mm <sup>2</sup>
Elongation	1.4%
Conductibility	94% IACS

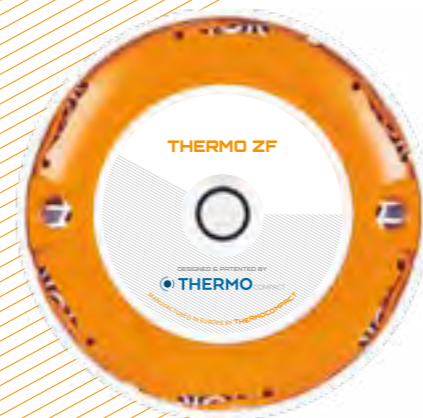

ZINC FREE EDM WIRE,  
WITH EXCEPTIONAL  
CONDUCTIBILITY

### AVAILABILITY BY SPOOL TYPE AND DIAMETER

	THERMO ZF	T125	T160	T200	K250	JP5	JP10	JP15
<b>0,20 mm</b> 0.008"	ZF	■	■	■		■	■	■
<b>0,25 mm</b> 0.010"	ZF	■	■	■	■	■	■	■
<b>0,30 mm</b> 0.012"	ZF	■	■	■	■	■	■	■

MANUFACTURED IN EUROPE BY THERMOCOMPACT  
MANUFACTURED IN ASIA BY HWA



CLICK HERE FOR  
MORE INFORMATIONS

Zinc free Wire

# THERMO ZF<sup>+</sup>

## SPECIAL MICRO ALLOYED COPPER

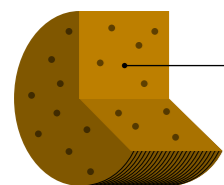

Special micro alloyed copper

THERMO ZF<sup>+</sup> is a new EDM wire free of zinc with a special micro alloyed copper.

It offers a processing speed higher than THERMO ZF<sup>+</sup> and maintain its high tensile strength.

Its special micro alloyed copper allows THERMO ZF<sup>+</sup> to obtain a high tensile strength.

### USAGE RECOMMENDED



ZINC FREE EDM WIRE WITH HIGH TENSILE STRENGTH THANKS TO ITS SPECIAL ALLOY



TURBINE BLADE

### CHARACTERISTICS

Material	Special micro alloyed copper
Tensile Strength	800N/mm <sup>2</sup>
Elongation	2.7%
Conductibility	72% IACS

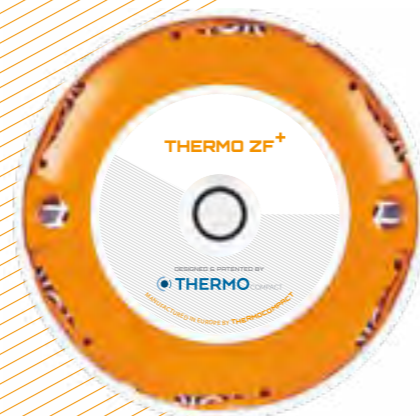

### AVAILABILITY BY SPOOL TYPE AND DIAMETER

	THERMO ZF <sup>+</sup>	T125	T160	T200	K250	JP5	JP10	JP15
0,20 mm 0.008"	ZF <sup>+</sup>	■	■	■		■	■	■
0,25 mm 0.010"	ZF <sup>+</sup>	■	■	■	■	■	■	■
0,30 mm 0.012"	ZF <sup>+</sup>	■	■	■	■	■	■	■

MANUFACTURED IN EUROPE BY THERMOCOMPACT  
MANUFACTURED IN ASIA BY HWA

[CLICK HERE FOR MORE INFORMATION](#)



Zinc free Wire

# THERMO ZF sigma®

## SPECIAL MICRO ALLOYED COPPER

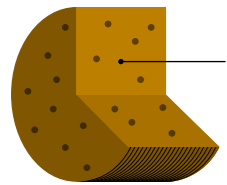

Special micro alloyed copper

THERMO ZF sigma® is a new EDM wire without zinc, offering superior performances :

- › high processing speed,
- › high conductivity.

The THERMO ZF sigma® is dedicated to aerospace production, particularly for nickel base alloys.

It is particularly recommended to improve the speed when cutting nickel based alloys and obtaining a straight part. Non volatile elements during machining process.

### USAGE RECOMMENDED



ZINC FREE EDM WIRE  
NON VOLATILE  
ELEMENTS DURING  
MACHINING PROCESS

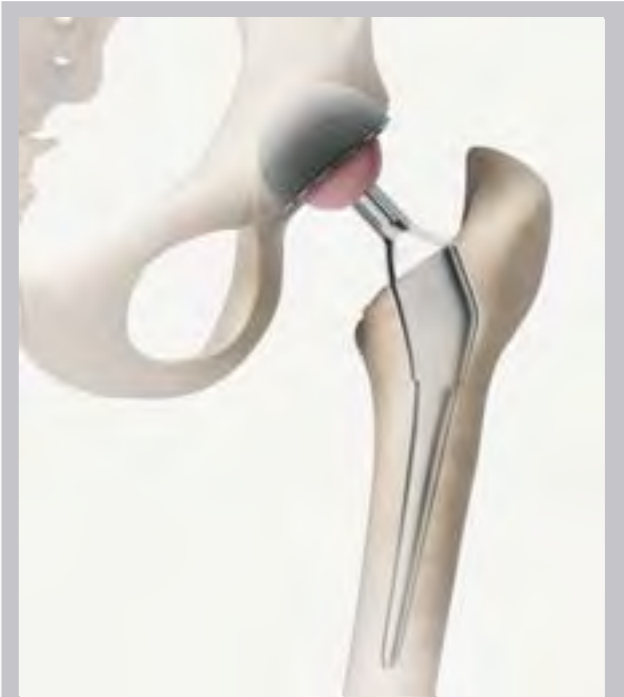

HIP PROTHESIS

SPOOLS:  
AVAILABLE SOON

### CHARACTERISTICS

Material	Spécial micro alloyed copper
Tensile Strength	800N/mm <sup>2</sup>
Elongation	3 to 6%
Conductibility	93% IACS

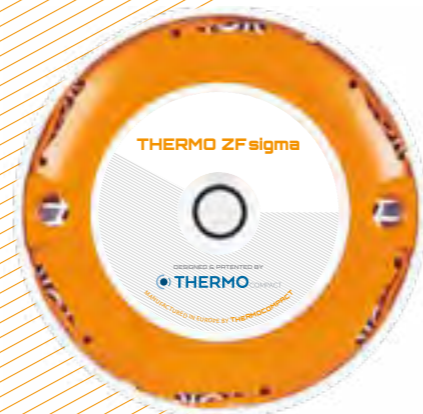

MANUFACTURED IN EUROPE BY THERMOCOMPACT  
MANUFACTURED IN ASIA BY HWA



# PLAN YOUR PRODUCTION

SPOOL MACHINING DURATION FOR 1 SPOOL

SPOOL TYPE	WIRE DIAMETER		NOMINAL WEIGHT PER SPOOL *		NOMINAL LENGTH PER SPOOL *		SPOOL MACHINING DURATION FOR 1 SPOOL			
	mm	inch	kg	lbs	m	ft	10m/min 33 ft/min	12m/min 39,4 ft/min	15m/min 49,21ft/min	16m/min 52,5ft/min
<b>K100</b>	0.07	0.003	1.8	4	58500	191929	98	81	65	61
	0.10	0.004	1.8	4	27000	88582	45	38	30	28
	0.127	0.005	1.8	4	16800	55118	28	23	19	18
	0.15	0.006	1.8	4	12000	39370	20	17	13	13
<b>K125</b>	0.10	0.004	4	8.8	60000	196850	100	83	67	63
<b>T125</b>	0.127	0.005	4	8.8	37300	122375	62	52	41	39
	0.15	0.006	4	8.8	26700	87598	45	37	30	28
	0.20	0.008	4	8.8	14900	48884	25	21	17	16
	0.25	0.01	4	8.8	9600	31496	16	13	11	10
	0.30	0.012	4	8.8	6600	21653	11	9	7	7
<b>K160</b>	0.127	0.005	8	17.6	74600	244750	124	104	83	78
<b>T160</b>	0.15	0.006	8	17.6	53400	175196	89	74	59	56
	0.20	0.008	8	17.6	29900	98097	50	42	33	31
	0.25	0.01	8	17.6	19200	62992	32	27	21	20
	0.30	0.012	8	17.6	13200	43307	22	18	15	14
	0.33	0.013	8	17.6	10700	35105	18	15	12	11
	<b>K200</b>	0.20	0.008	16	35.2	59800	196194	100	83	66
<b>T200</b>	0.25	0.01	16	35.2	38400	125984	64	53	43	40
	0.30	0.012	16	35.2	26500	86942	44	37	29	28
	0.33	0.013	16	35.2	21400	70210	36	30	24	22
<b>K250</b>	0.25	0.01	25	55	60000	196850	100	83	67	63
	0.30	0.012	25	55	41400	135826	69	58	46	43
	0.33	0.013	25	55	33400	109580	56	46	37	35
<b>K355</b>	0.25	0.01	45	99	106000	347768	177	147	118	110
	0.30	0.012	45	99	73500	241141	123	102	82	77
	0.33	0.013	45	99	60700	199146	101	84	67	63

## STANDARD DIN

SPOOL MACHINING DURATION FOR 1 SPOOL

SPOOL TYPE	WIRE DIAMETER		NOMINAL WEIGHT PER SPOOL *		NOMINAL LENGTH PER SPOOL *		SPOOL MACHINING DURATION FOR 1 SPOOL			
	mm	inch	kg	lbs	m	ft	10m/min 33 ft/min	12m/min 39,4 ft/min	15m/min 49,21ft/min	16m/min 52,5ft/min
<b>JP5</b>	0.10	0.004	5	11	75000	246062	125	104	83	78
	0.13	0.005	5	11	46700	153215	78	65	52	49
	0.15	0.006	5	11	33500	109908	56	47	37	35
	0.20	0.008	5	11	18700	61352	31	26	21	19
	0.25	0.01	5	11	12000	39370	20	17	13	13
	0.30	0.012	5	11	8300	27231	14	12	9	9
<b>JP10</b>	0.20	0.008	10	22	37500	123031	63	52	42	39
	0.25	0.01	10	22	24000	78740	40	33	27	25
	0.30	0.012	10	22	16600	54462	28	23	18	17
<b>JP15</b>	0.20	0.008	20	44	74800	245406	125	104	83	78
	0.25	0.01	20	44	48000	157480	80	67	53	50
	0.30	0.012	20	44	33100	108595	55	46	37	34
	0.33	0.013	20	44	26500	86942	44	37	29	28

\* Average weight and length

## STANDARD JP

# DATA FOR PLANNING YOUR DEMAND AND STORAGE

SPOOL TYPE	SPOOL WEIGHT	SPOOLS PER PALLET	SPOOLS PER BOX	WEIGHT PER BOX	BOXES PER LAYER NUMBER OF LAYER	NET WEIGHT PER PALLET
K100	1,8 Kg 4 Lbs	diam 0,07 / 0,10 36	4 (with individual pre packaging in box)	7,2 Kg 16 Lbs	6 boxes 1 layer + 3 boxes	64,8 kg 144 lbs
	2 Kg 4,4 Lbs	diam 0,10 24	2 (with individual pre packaging in box)	8kg 8,8 lbs	6 boxes 2 layers	96 kg 140.8 lbs
K125 T125	4 Kg 8,8 Lbs	diam 0,10 0,127 / 0,15 48	1	4kg 8,8 lbs	24 boxes 2 layers	192 kg 423.3 lbs
		diam 0,20 / 0,25 / 0,30 96	2 (with individual pre packaging in box)	8kg 17,6 lbs	10 boxes 2 layers + 4 boxes	384 kg 844.8 lbs
	4		16kg 32,2 lbs	6 boxes 4 layers		
K160 T160	8 Kg 17,6 Lbs	diam 0,15 30 (half pallet)	2	35,2 lbs	10 boxes. 1 layer + 5 boxes	240 kg 528 lbs
		diam 0,20 / 0,25 / 0,30 / 0,33 60	2	16kg	10 boxes 3 layers	480 kg 1056 lbs
K200 T200	16 Kg 35,2 Lbs	24	1	16 Kg 35,2 Lbs	12 boxes 2 layers	384 kg 844.8 lbs
K250	25 Kg 55 Lbs	18	1	25 kg 55 lbs	9 boxes 2 layers	450 kg 990 lbs
K355	45Kg 99 Lbs	6	1	45kg 99 lbs	6 box 1 layer	270 kg 594 lbs
JP5	5 Kg 11 Lbs	diam 0,15 48	4	20 kg 44 lbs	6 boxes 2 layers	240 kg 528 lbs
		96			6 boxes 4 layers	480 kg 1056 lbs
JP10	10 Kg 22 Lbs	36	2	20 kg 44 lbs	6 boxes 3 layers	360 kg 792 lbs
JP15	20 Kg 44 Lbs	24	1	20 kg 44 lbs	12 boxes 2 layers	480 kg 1056 lbs

## PALLET DIMENSIONS

PALLET TYPE	LENGTH (L)	WIDTH (W)
EU (European pallet, no consigned)	120 cm 47,2 in	80 cm 31,5 in
North America (US pallets, no wooden crates). IPP certified	111 cm 43,7 in	79 cm 31,1 in
Asia (wooden crates) IPP certified	112 cm 44,1 in	79 cm 31,1 in

Maximum weight per pallet: 700 kg

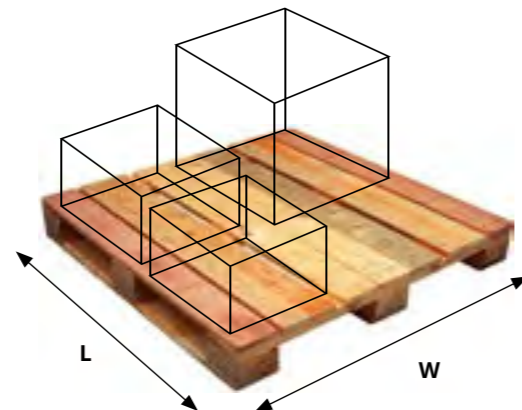

## TECSPPOOL® ANTI ROTATION SYSTEM PATENTED BY THERMOCOMPACT

FOR A BETTER **STORAGE** AND **HANDLING**  
 AVAILABLE FOR **T125, T160** ET **T200** EDM WIRE SPOOLS  
 ON STANDARD **DIN** SIZES

### WAY OF FUNCTIONING

One manual rotation of the side flange is enough to free the lock bolts of the spool.

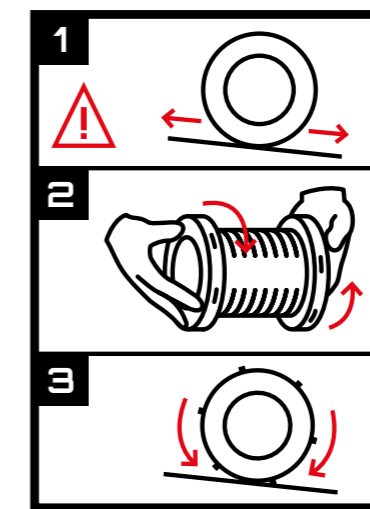

### TECSPPOOL® BENEFITS

- › Spool is stopped in horizontal position
- › Stability guaranteed on incline surface up to 30% slope.
- › TecSpool® avoids wire tangles of the outer layer
- › Easy storage display
- › Flanges are made with recycled material



## SPOOLS STORAGE RECOMMENDATIONS

**STORAGE HORIZONTALLY, IN ITS PACKAGING**

**KEEP DRY, DO NOT OPEN THE PACKAGING BEFORE USE**

**WIRE TO BE USED WITHIN 18 MONTHS**

## WHERE TO FIND US

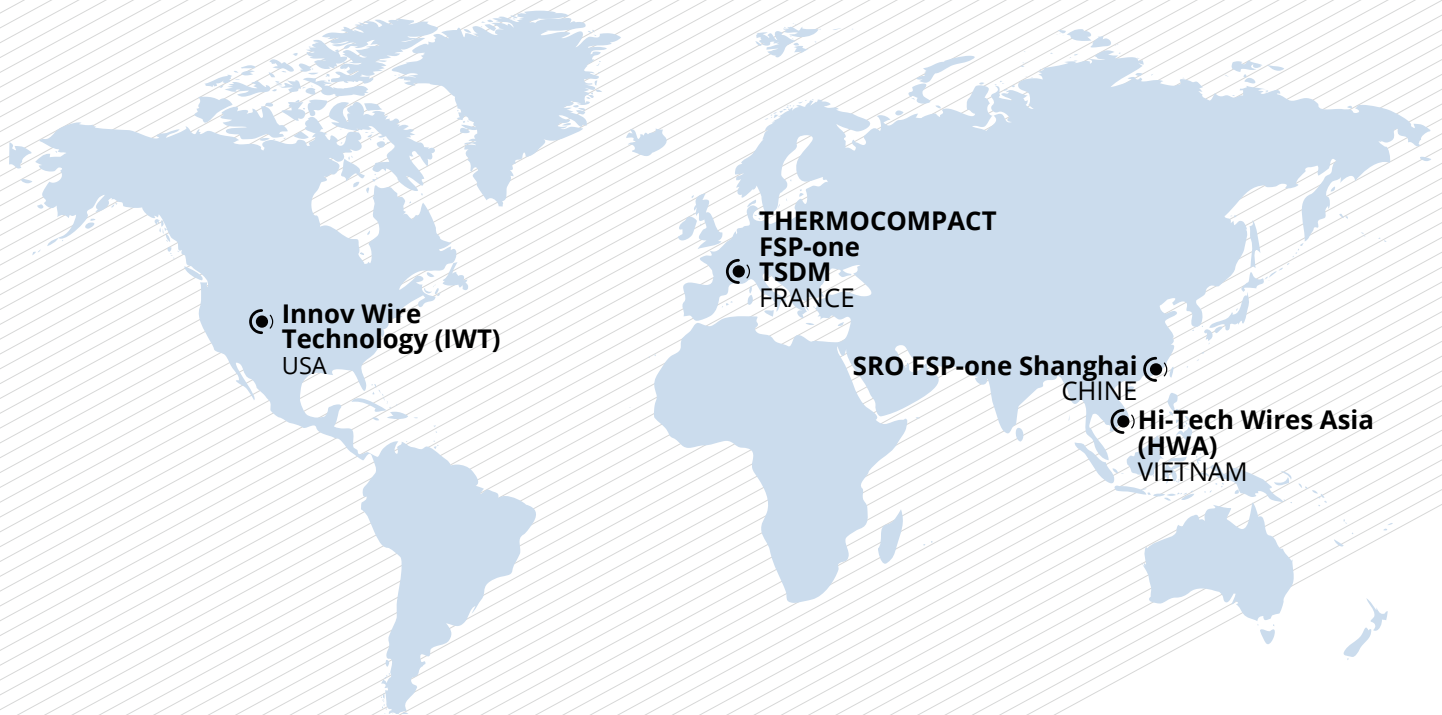

● **Innov Wire  
Technology (IWT)**  
USA

**THERMOCOMPACT  
FSP-one  
TSDM**  
FRANCE

**SRO FSP-one Shanghai** ●  
CHINE

● **Hi-Tech Wires Asia  
(HWA)**  
VIETNAM

### **THERMOCOMPACT**

181 route des Sarves – Z.I. Les Iles  
74370 EPAGNY METZ-TESSY  
FRANCE

45°55'38.5"N / 6°06'53.3"E

Tel +33 (0) 4 50 27 20 02

edm-wires@thermocompact.com  
[www.thermocompact.com](http://www.thermocompact.com)

### **HI-TECH WIRES ASIA**

46 Road N°6, VSIP1,  
Thuan An, Binh Duong  
VIETNAM

10°54'58.668"N / 106°41'45.784"E

Tel +84 (650) 3769 131

contact@hitechwiresasia.com  
[www.hitechwiresasia.com](http://www.hitechwiresasia.com)

